

BMg Pro



PROFESSIONAL SCRUBBING MACHINES

USE AND MAINTENANCE MANUAL

 **FIMAP**[®]



ORIGINAL INSTRUCTIONS DOC. 10093228 - Ver. AA - 12-2019

CONTENTS

CONTENTS	3
LOCATION OF THE MAIN MACHINE COMPONENTS	5
GENERAL DESCRIPTION	6
GENERAL SAFETY REGULATIONS.....	6
SYMBOLS USED IN THE MANUAL	6
PURPOSE AND CONTENT OF THE MANUAL.....	7
TARGET GROUP.....	7
PRESERVATION OF THE USER.....	7
ON CONSIGNMENT OF THE MACHINE	7
INTRODUCTORY COMMENT.....	7
IDENTIFICATION DATA.....	7
TECHNICAL DESCRIPTION.....	7
INTENDED USE.....	7
SAFETY.....	7
REGULATIONS.....	7
SERIAL NUMBER PLATE.....	8
TECHNICAL DATA	8
GENERAL MACHINE DATA.....	8
GENERAL MACHINE PERFORMANCE.....	9
SCRUBBING SYSTEM PERFORMANCE	9
VACUUM HEAD PERFORMANCE (2ST MOTOR).....	9
VACUUM HEAD PERFORMANCE (3ST MOTOR, OPTIONAL).....	9
TRACTION MOTOR ASSEMBLY PERFORMANCE.....	10
MACHINE POWER SUPPLY TYPE	10
SYMBOLS AND LABELS USED ON THE MACHINE	10
SYMBOLS USED ON THE MACHINE.....	10
LABELS USED ON THE MACHINE.....	11
CONTROL SCREEN.....	12
CONTROL DISPLAY.....	12
PREPARATION OF MACHINE	13
HANDLING THE PACKAGED MACHINE	13
HOW TO UNPACK THE MACHINE	13
HOW TO MOVE THE MACHINE	14
MACHINE SAFETY.....	14
TYPE OF BATTERY TO BE USED	15
INSERTING THE BATTERIES IN THE MACHINE.....	15
BATTERY MAINTENANCE AND DISPOSAL.....	15
RECHARGING THE BATTERIES	15
FILLING THE SOLUTION TANK.....	16
DETERGENT SOLUTION.....	16
INSERTING WATER SYSTEM FILTER	17
FITTING THE BRUSH HEAD BRUSHES (SINGLE-BRUSH VERSION).....	17
FITTING THE BRUSH HEAD BRUSHES (DUAL-BRUSH VERSION)	17
ASSEMBLING THE ABRASIVE PAD (ORBITAL VERSION)	18
ASSEMBLING THE SQUEEGEE BODY.....	18
PREPARING TO WORK	18
STARTING WORK	19
HOUR METER	19
BATTERY CHARGE LEVEL INDICATOR	19
SCRUBBING WITH DRYING.....	20
SCRUBBING WITHOUT DRYING	20
DRYING.....	20
OVERFLOW DEVICE	20
ADDITIONAL FUNCTIONS	21
ECO MODE.....	21

MANUAL MODE.....	22
PROGRAM ZONE MODE.....	22
REVERSE FUNCTION.....	22
BUZZER.....	22
EXTRA BRUSH HEAD PRESSURE FUNCTION.....	22
DETERGENT SOLUTION RECYCLING SYSTEM.....	23
AUTOMATIC REQUEST FOR TECHNICAL ASSISTANCE (FFM VERSIONS).....	23
AUTOMATIC DETERGENT DOSING SYSTEM (FSS VERSIONS).....	23
ADJUSTMENT OF THE DETERGENT SOLUTION FLOW.....	23
REGULATING THE FORWARD SPEED.....	24
SILENT FUNCTION.....	24
ALARM SCREEN.....	24
EMERGENCY BUTTON.....	24
LIQUID SUCTION WAND KIT.....	24
SPRAY GUN KIT.....	25
AT THE END OF THE WORK.....	26
ROUTINE MAINTENANCE.....	26
DRAINING THE RECOVERY TANK.....	27
CLEANING THE SQUEEGEE BODY.....	27
CLEANING THE BRUSH HEAD BRUSH (SINGLE BRUSH VERSION).....	27
CLEANING THE BRUSH HEAD BRUSHES (DUAL-BRUSH VERSION).....	28
CLEANING THE RECOVERY TANK FILTERS.....	28
CLEANING THE RECYCLE FILTER (FLR VERSIONS).....	28
EMPTYING THE SOLUTION TANK.....	29
CLEANING THE WATER SYSTEM FILTER.....	29
CLEANING THE VACUUM TUBE.....	29
CLEANING THE DETERGENT TANK (FSS VERSIONS).....	29
EXTRAORDINARY MAINTENANCE.....	30
REPLACING THE SQUEEGEE BODY RUBBER BLADES.....	30
REPLACING THE BRUSH HEAD SPLASH GUARD.....	30
REPLACING THE BRUSH HEAD BRUSH (SINGLE BRUSH VERSION).....	31
REPLACING THE BRUSH HEAD BRUSHES (DUAL BRUSH VERSION).....	31
REPLACING THE ABRASIVE PAD (ORBITAL VERSION).....	31
ADJUSTMENT INTERVENTIONS.....	32
ADJUSTING THE SQUEEGEE BODY'S RUBBER BLADES.....	32
ADJUSTING BRUSH HEAD BODY SIDE SPLASH GUARDS.....	33
CHOOSING AND USING BRUSHES.....	33
TROUBLESHOOTING.....	34
EC DECLARATION OF CONFORMITY.....	36

LOCATION OF THE MAIN MACHINE COMPONENTS

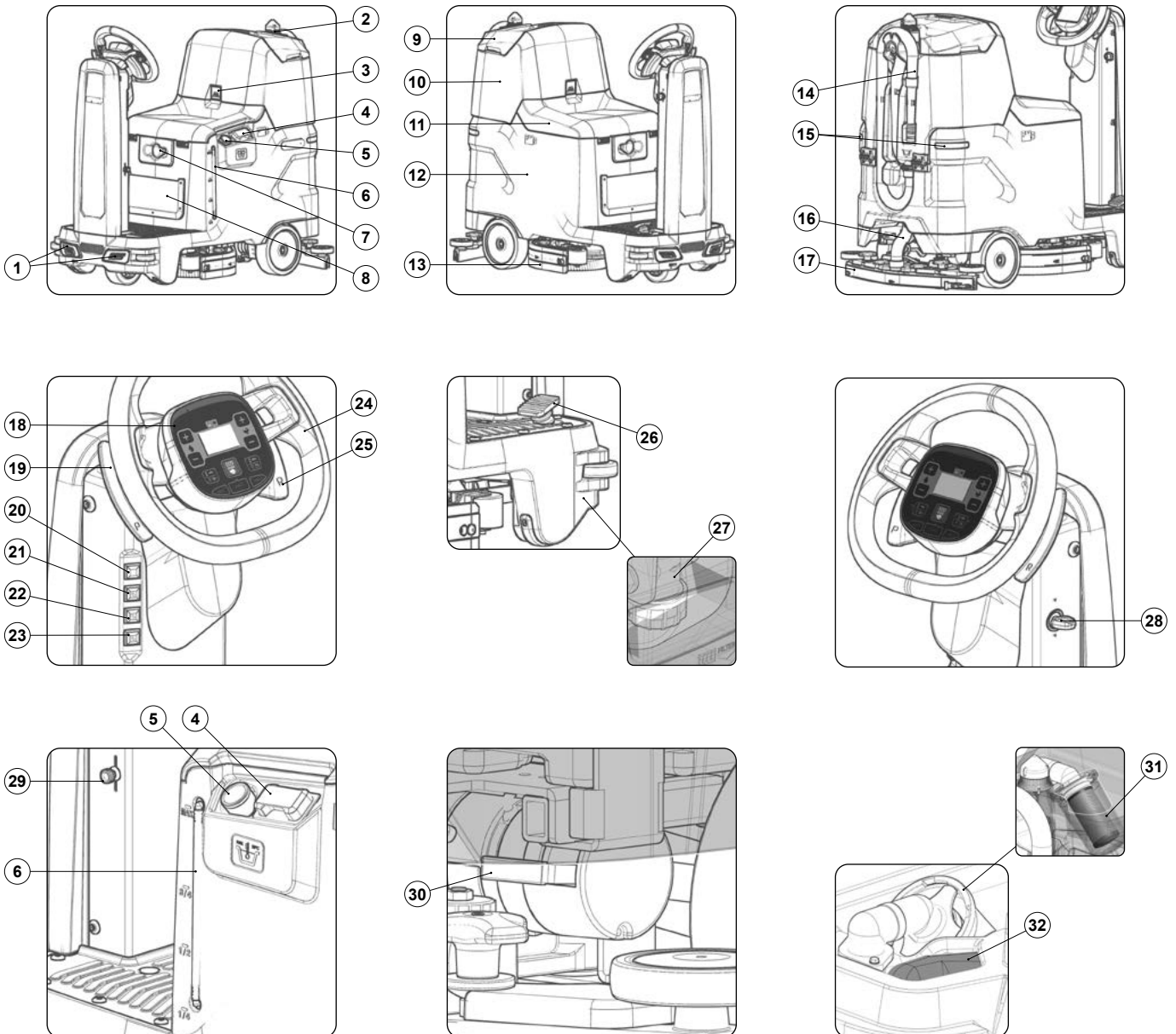

The machine's main components are the following:

1. Front working lights.
2. Blinking light.
3. Recovery tank rotation stop lever.
4. Solution tank dosing cap.
5. Solution tank rapid filling hose.
6. Solution tank level hose.
7. Emergency button.
8. Object holder net.
9. Recovery tank lid.
10. Recovery tank.
11. Operator's seat.
12. Solution tank.
13. Scrubbing brush head body .
14. Recovery tank drainage hose.
15. Tail lights.
16. Squeegee vacuum hose.
17. Squeegee body.
18. Command display.
19. Brush head extra pressure selection lever.
20. Horn button.
21. Optional automatic detergent dispenser kit control button (versions with FSS) or optional detergent solution recycling kit (versions with FLR).
22. Optional spray gun kit control button.
23. Optional liquid suction wand kit control button.
24. Steering wheel.
25. Reverse gear selection lever.
26. Drive pedal.
27. Detergent solution filter.
28. Main key switch.
29. Detergent solution tap control lever.
30. Electric brake control lever.
31. Suction motor air intake filter.
32. Recovery tank filter.















GENERAL DESCRIPTION

The descriptions contained in this document are not binding. The company therefore reserves the right to make any modifications at any time to elements, details, or accessory supply, as considered necessary for reasons of improvement or manufacturing/commercial requirements. The reproduction, even partial, of the text and drawings contained in this document is prohibited by law. **The company reserves the right to make any technical and/or supply modifications. The images are for reference purposes only, and are not binding in terms of design and supply.**

GENERAL SAFETY REGULATIONS

Before using the machine, please read the following document carefully and follow the instructions contained herein, along with the instructions in the document supplied with the machine itself, "GENERAL SAFETY REGULATIONS" (document code 10083659).

SYMBOLS USED IN THE MANUAL

	Open book symbol with an "i": Indicates the need to consult the instruction manual.
	Open book symbol: Tells the operator to read the user manual before using the device.
	Covered place symbol: The operations preceded by this symbol must always be carried out in a dry, covered area.
	Information symbol: Indicates additional information for the operator, to improve the use of the device.
	Warning symbol: Carefully read the sections preceded by this symbol meticulously following the instructions indicated for the safety of the operator and the device.
	Danger symbol (corrosive substances): The operator should always wear protective gloves to avoid the risk of serious injury to the hands caused by corrosive substances.
	Danger symbol (battery acid leakage): Indicates the danger of leaking acid or acid fumes from the batteries while they are being recharged.
	Danger symbol (moving carriages): Indicates that the packed product should be handled with suitable carriages that conform to legal requirements.
	Mandatory room ventilation symbol: Informs the operator that the room must be ventilated while the batteries are being recharged.
	Symbol indicating the compulsory use of protective gloves: Indicates that the operator should always wear protective gloves, to avoid the risk of serious injury to his hands from sharp objects.
	Symbol indicating the compulsory use of tools: Informs the operator of the need to use tools not included with the machine.
	Symbol indicating a treading ban: Informs the operator that it is forbidden to tread on machine components, as this could lead to serious injury.
	Recycling symbol: Tells the operator to carry out the operations in compliance with environmental regulations in force in the place where the appliance is being used.
	Disposal symbol: Carefully read the sections marked with this symbol for disposing of the appliance.

PURPOSE AND CONTENT OF THE MANUAL

The aim of this manual is to provide customers with all the information needed to use the machine in the safest, most appropriate and most autonomous way. This includes information concerning technical aspects, safety, operation, downtime, maintenance, spare parts and scrapping. The operators and qualified technicians must carefully read the instructions in this manual before carrying out any operations on the machine. If in doubt about the correct interpretation of instructions, contact your nearest FIMAP Customer Service Centre to obtain the necessary clarifications.

TARGET GROUP

This manual is written both for operators and for qualified machine maintenance technicians. Operators must not perform operations that should be carried out by qualified technicians. The manufacturer is not liable for damages resulting from failure to comply with this veto.

PRESERVATION OF THE USER

The Use and Maintenance Manual must be stored in its special pouch close to the machine, protected from liquids and anything else that could compromise its legibility.

ON CONSIGNMENT OF THE MACHINE

When the machine is consigned to the customer, an immediate check must be performed to ensure all the material mentioned in the shipping documents has been received, and also to check the machine has not suffered damage during transportation. If this is the case, the carrier must ascertain the extent of the damage at once, informing our customer service office. It is only by prompt action of this type that the missing material can be obtained, and compensation for damage successfully claimed.

INTRODUCTORY COMMENT

Any floor scrubbing machine can only work properly and effectively if used correctly and kept in full working order by performing the maintenance operations described in the attached documentation. We therefore suggest you read this instruction booklet carefully and read it again whenever difficulties arise while using the machine. If necessary, remember that our assistance service (organised in collaboration with our dealers) is always available for advice or direct intervention.

IDENTIFICATION DATA

For technical assistance or to request replacement parts, always give the model, the version and the serial number (written on the relevant plate).

TECHNICAL DESCRIPTION

The **BMg** is a floor scrubbing machine that's capable of handling a wide variety of floors and types of dirt thanks to the mechanical action of one or two brushes and the chemical action of a water-detergent solution. As it advances, it collects the dirt removed, as well as the detergent solution not absorbed by the flooring itself. **The machine must only be used for this purpose.**

INTENDED USE

This scrubbing machine was designed and built for the cleaning (scrubbing and drying) of smooth, compact flooring in the commercial, residential and industrial sectors by a qualified operator in proven safety conditions. The scrubbing machine is not suitable for cleaning rugs or carpet floors. It is only suitable for use in closed (or at least covered) places.



ATTENTION: the machine is not suitable for use in the rain, or under water jets.



IT IS FORBIDDEN to use the machine in environments with an explosive atmosphere to clean dangerous powders or flammable liquids. In addition, it is not suitable as a means of transport for people or objects.

SAFETY

Operator cooperation is paramount for accident prevention. No accident prevention programme can be effective without the full cooperation of the person directly responsible for machine operation. The majority of occupational accidents that happen either in the workplace or whilst moving are caused by failure to respect the most basic safety rules. An attentive, careful operator is most effective guarantee against accidents and is fundamental in order to implement any prevention programme.

REGULATIONS

All references to forwards and backwards, front and rear, right and left indicated in this manual should be understood as referring to the operator in a driving position with his hands on the steering wheel.

SERIAL NUMBER PLATE

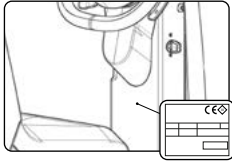

The serial number plate is located at the rear of the steering column, and indicates the machine's general characteristics, including its serial number. The serial number is a very important piece of information and should always be provided together with any request for assistance or when purchasing spare parts. The serial number plate contains the following:

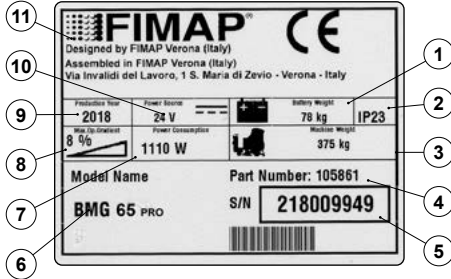

1. The weight of the batteries used to power the appliance (expressed in Kg).
2. The IP protection rating of the appliance.
3. The gross weight of the appliance (expressed in Kg).
4. The identification code of the appliance.
5. The serial number of the appliance.
6. The name of the appliance.
7. The nominal power consumed by the appliance (expressed in W).
8. The maximum grade that the appliance can handle during work activities (expressed in %).
9. The year in which the appliance was manufactured.
10. The nominal voltage of the appliance (expressed in V).
11. The commercial name of the appliance and the manufacturer's address.

TECHNICAL DATA

GENERAL MACHINE DATA

DESCRIPTION	U/M [KMS]	BMg 56 Pro	BMg 65 Pro	BMg 50 Orbital Pro
Nominal input power [IEC 60335-2-72; IEC 62885-9]	kW	1,22	1,72	1,40
Solution tank capacity [IEC 62885-9]	l	51	51	51
Recovery tank capacity [IEC 62885-9]	l	55	55	55
Solution tank capacity (versions with automatic dosing system)	l	3	3	3
Minimum inversion corridor [IEC 62885-9]	mm	1830	1830	1830
Machine dimensions during work (length x height x width)	mm	1285	1285	1285
	mm	1189	1189	1189
	mm	641	709	641
Machine dimensions during transport [IEC 62885-9]	mm	640	709	640
	mm	350	350	350
	mm	190	190	190
Battery compartment dimensions (length x height x width)	mm	310	310	310
	kg	160	172	170
	kg	238	250	248
GVW [IEC 60335-2-72; IEC 62885-9]	kg	375	387	385
Maximum specific pressure on wheels [IEC 62885-9]	N/mm ²	0,8	0,8	0,8
Maximum sound pressure level in operator seat [ISO 11201] (L _{pA})	dB	64,8	66.1	65,5
Sound power level [IEC 60335-2-72; IEC 62885-9; ISO 3744] (L _{wA})	dB	78.2	78.2	78,8
Uncertainty K _{pA}	dB	±1,5	±1,5	±1,5
Hand-arm vibrations [IEC 60335-2-72; IEC 62885-9; ISO 5349-1]	m/s ²	0.62	0,79	1,21
Whole body vibrations [IEC 60335-2-72; IEC 62885-9; ISO 2631-1]	m/s ²	0,47	0,33	0,31
Vibration uncertainty		±4%	±4%	±4%
IP test [IEC 60335-2-72; IEC 60529]		IP23	IP23	IP23
Electrical protection class (machine # battery charger on board) [IEC 60335-2-72; IEC 60335-1]		III # I	III # I	III # I

GENERAL MACHINE PERFORMANCE

DESCRIPTION	U/M [KMS]	BMg 56 Pro	BMg 65 Pro	BMg 50 Orbital Pro
Theoretical productivity (with the speed value equal to 90% of V_{MAX})	m ² /h	2770	3220	2525
Actual productivity (with the speed value equal to 90% of V_{MAX})	m ² /h	1850	2145	1685
Maximum uphill gradient during transfer with machine in working order	%	17	17	17
Maximum slope during work (GVW)	%	8	8	8
Time taken to empty recovery tank [IEC 62885-9]	min.	1'40"	1'40"	1'40"
Water consumption [IEC 62885-9]	ml/m ²	31	26	34
Maximum ambient temperature for correct machine operation	°C	40	40	40
Maximum ambient temperature for correct machine operation during scrubbing phase	°C	5	5	5

SCRUBBING SYSTEM PERFORMANCE

DESCRIPTION	U/M [KMS]	BMg 56 Pro	BMg 65 Pro	BMg 50 Orbital Pro
Working width [IEC 62885-9]	mm	560	655	500
Nominal power of brush motor/s [IEC 62885-9]	W	500	500	680
Total width of brushes [IEC 62885-9]	mm	550	2x340	508
Maximum number of free brush rotations [IEC 62885-9]	rpm	170	150	-
Maximum number of free brush rotations (while working, maximum pressure) [IEC 62885-9]	rpm	133	132	-
Maximum force of the brush head on the floor [IEC 62885-9]	N	490	588	490
Maximum pressure of the brush head on the floor [IEC 62885-9]	N/cm ²	0,10	0,10	0,27
Maximum detergent solution flow [IEC 62885-9]	l/min	3,6	3,6	3,6

VACUUM HEAD PERFORMANCE (2ST MOTOR)

DESCRIPTION	U/M [KMS]	BMg 56 Pro	BMg 65 Pro	BMg 50 Orbital Pro
Squeegee width	mm	785	785	785
Drying track [IEC 62885-9]	mm	830	830	830
Nominal power of vacuum motor/s [IEC 62885-9]	W	422	422	422
Maximum vacuum [IEC 62885-9; IEC 60312-1]	kPa	11,9	11,9	11,9
Maximum air flow [IEC 62885-9]	l/s	27	27	27

VACUUM HEAD PERFORMANCE (3ST MOTOR, OPTIONAL)

DESCRIPTION	U/M [KMS]	BMg 56 Pro	BMg 65 Pro	BMg 50 Orbital Pro
Squeegee width	mm	785	785	785
Drying track [IEC 62885-9]	mm	830	830	830
Nominal power of vacuum motor/s [IEC 62885-9]	W	584	584	584
Maximum vacuum [IEC 62885-9; IEC 60312-1]	kPa	18,1	18,1	18,1
Maximum air flow [IEC 62885-9]	l/s	29	29	29

TRACTION MOTOR ASSEMBLY PERFORMANCE

DESCRIPTION	U/M [KMS]	BMg 56 Pro	BMg 65 Pro	BMg 50 Orbital Pro
Nominal power of traction motor [IEC 62885-9]	W	300	300	300
Maximum transfer speed [IEC 62885-9]	km/h	5.5	5.5	5.5
Maximum working speed	km/h	2.8	2.8	2.8









MACHINE POWER SUPPLY TYPE

DESCRIPTION	U/M [KMS]	BMg 56 Pro	BMg 65 Pro	BMg 50 Orbital Pro
Battery capacity (C ₅) [IEC 62885-9]	Ah	110	110	110
DOD 60% battery charge time (machine with on-board battery charger)	h:min	6:00	6:00	6:00

















NB: two TP12110 batteries were used during the data collection phases.

SYMBOLS AND LABELS USED ON THE MACHINE

SYMBOLS USED ON THE MACHINE

	<p>Filter body position symbol: Applied to the front of the machine to indicate the position of the solution tank filter.</p>
	<p>Extra pressure activation/deactivation lever position symbol: Applied to the central brush head's extra pressure activation/deactivation lever.</p>
	<p>Reverse gear activation/deactivation lever position symbol: Applied to the reverse gear activation/deactivation lever.</p>
	<p>Recovery tank drainage hose symbol: Applied to the back of the machine to identify the recovery tank's drainage hose.</p>
	<p>Symbol for maximum temperature for filling the solution tank: Applied to the left-hand side of the machine's solution tank to indicate the maximum temperature of the water that can be used to safely fill the solution tank.</p>
	<p>Solution tank filling symbol: Located on the left side of the machine's solution tank to indicate the amount of water or detergent solution in the tank. The symbol on the side indicates that the tank is full to about a quarter of its capacity.</p>
	<p>Solution tank filling symbol: Located on the left side of the machine's solution tank to indicate the amount of water or detergent solution in the tank. The symbol on the side indicates that the tank is full to about a half of its capacity.</p>
	<p>Solution tank filling symbol: Located on the left side of the machine's solution tank to indicate the amount of water or detergent solution in the tank. The symbol on the side indicates that the tank is full to about three-quarters of its capacity.</p>
	<p>Solution tank filling symbol: Located on the left side of the machine's solution tank to indicate the amount of water or detergent solution in the tank. The symbol on the side indicates that the tank is full.</p>

LABELS USED ON THE MACHINE

	<p>Main switch symbol: Applied to the control panel, positioned on the front of the machine, to indicate the main switch.</p>
	<p>Label for detergent solution tap command: Applied in the vicinity of the control column to identify the detergent solution tap's control lever.</p>
	<p>Label indicating the need to read the Use and Maintenance Manual: Applied in the vicinity of the steering column in order to remind the operator to read the user and maintenance manual before using the machine.</p>
	<p>Label indicating the need to read the Use and Maintenance Manual: Used in the brush head body, and indicates the prohibition to approach the brush head while the brush is moving.</p>
	<p>Warning label to read the user manual of the battery charger (versions with Battery charger): Applied in the vicinity of the steering column indicating to read the user manual of the battery charger. Also indicates to pay attention to when to perform the charging cycle and how long it should last.</p>
	<p>Battery charging sequence label (versions without Battery Charger): Located near the steering column, indicating the sequence to perform to recharge the batteries correctly.</p>
	<p>Visible daily maintenance label: Applied near the steering column, indicating to tighten the machine's water tap after every work cycle and to clean the filters and the squeegee.</p>
	<p>Warning label during battery charging: Located near the steering column, listing the warnings to perform when recharging the batteries.</p>
	<p>Water system filter maintenance label: Applied near the water system filter to remind the user to clean it after each work cycle.</p>
	<p>Spray gun control label (optional): Applied near the steering column to indicate the control button for the optional spray gun kit. While on the rear of the machine to indicate the spray gun support hook.</p>
	<p>Water system pump box label: Used on the box containing the machine's water system pumps to indicate the correct connection of the pipes present in the system.</p>
	<p>Detergent solution automatic dosing system warning label (versions with FSS): Used in the vicinity of the detergent tank to indicate which type of pH can be used with the FSS system without damaging it.</p>
	<p>Detergent dilution label (versions with FSS): Used in the vicinity of the detergent tank to indicate the capacity of the detergent tank and the dilution percentage of the FSS system.</p>
	<p>Detergent solution automatic dosing system activation key label (versions with FSS): Used on the steering column to indicate the control button of the detergent solution automatic dosing system.</p>
	<p>Liquids suction wand kit components position label: Used at the front part of the steering column to indicate how to position the liquid suction wand pipes.</p>
	<p>Liquids suction wand kit components position label: Used on the lid of the recovery tank to indicate how to position the coiled hose and the accessory of the liquids suction wand.</p>



Label warning about the risk of crushed hands:
Indicates danger to hands due to crushing between two surfaces.



Acoustic signalling device control label:
Applied in the vicinity of the steering column to indicate the acoustic signalling device's control button.



Detergent solution recycling system activation button label (versions with FLR):
Used on the steering column to indicate the control button of the detergent solution recycling system.



Automatic detergent solution system activation key label (versions with FSS):
Used on the steering column to indicate the control button of the automatic detergent solution dosing system.

CONTROL SCREEN



The control screen is divided in:

1. Buttons for movement speed adjustment.
2. "ECO MODE" control button.
3. Brush head control/ brush uncoupling button (only for the single-brush version).
4. "AREA 2" program activation button.
5. "AREA 3" program activation button.
6. "AREA 1" program activation button.
7. Squeegee / FNC "FIMAP NOISE CANCELLING" function control button.
8. Buttons for water flow selector.
9. Control display.

CONTROL DISPLAY

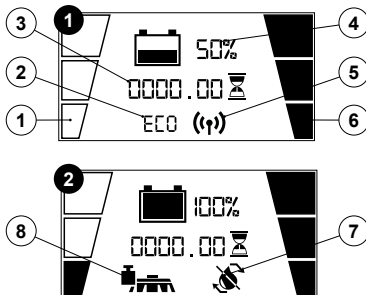

The control display is divided in:

1. Detergent solution level in the machines water system.
2. ECO-MODE active symbol.
3. Hour meter.
4. Battery charge level.
5. Management system symbol of the fleet "connected" (versions with FFM).
6. Forward speed level of the machine.
7. Detergent solution recycling system deactivation symbol (versions with FLR).
8. Brush head extra pressure function "active" symbol.

PREPARATION OF MACHINE

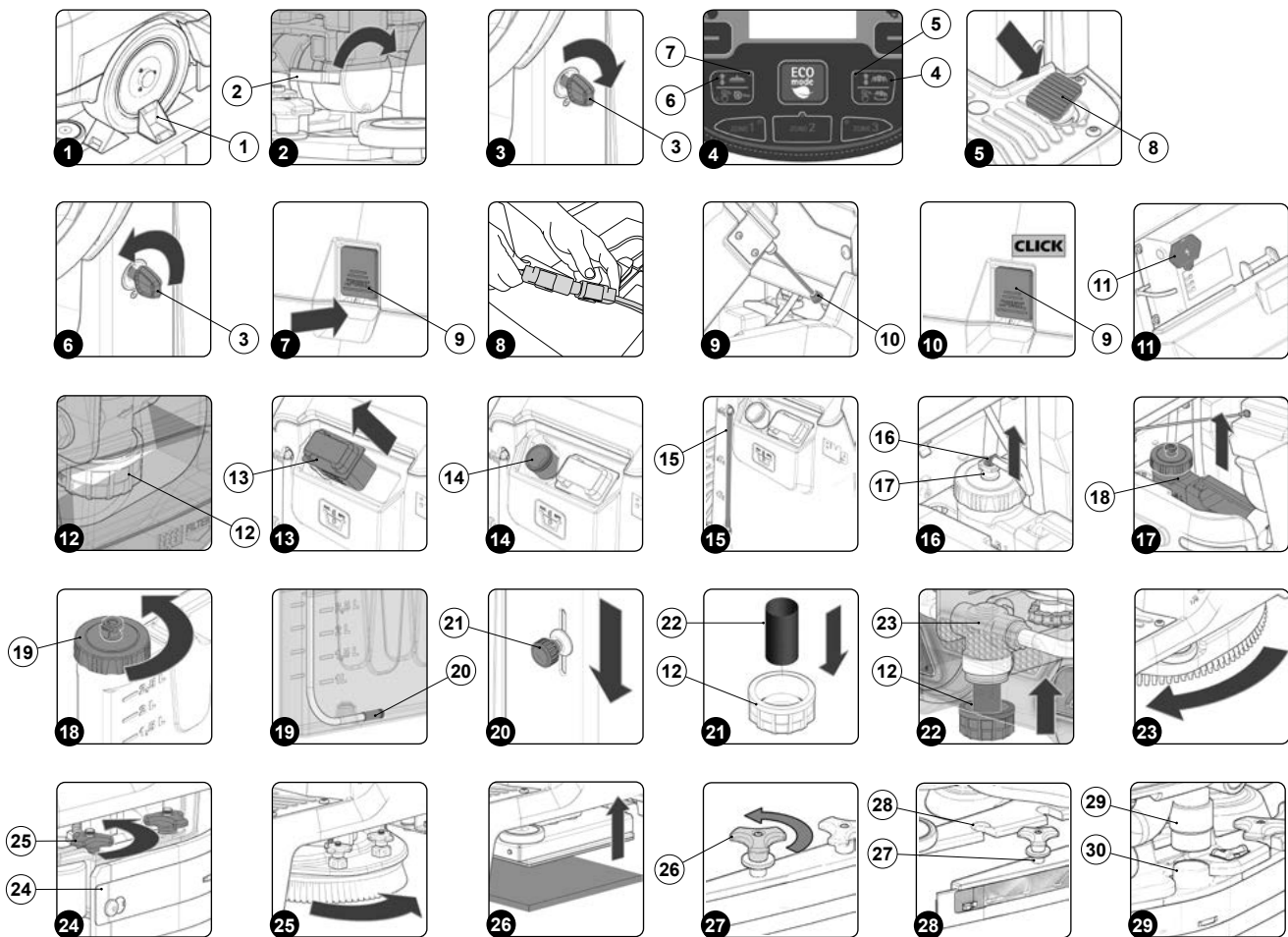

HANDLING THE PACKAGED MACHINE

The machine's overall weight including packaging is 205Kg. The external dimensions of the package are: width 750mm; length 1460mm and height 1385mm.

i N.B.: it is recommended that all the packaging components be kept for any future machine transportation.

⚠ DANGER: Move the packaged product with handling equipment that complies with legal requirements regarding size and mass of the packaging.

HOW TO UNPACK THE MACHINE

The machine is shipped in specific packaging. To remove it, proceed as follows:

1. Place the lower part of the outer packaging in contact with the floor.

i N.B.: use the pictograms printed on the box as a reference.

2. Remove the outer package.

⚠ WARNING: the machine is contained in specific packaging materials, whose elements (plastic bags, staples, etc.) can pose potential hazards, and must not be left within reach of children, disabled persons, etc.

⚠ CAUTION: It is recommended to wear the appropriate PPE (Personal Protective Equipment), suitable for the work to be carried out.

3. Insert a ramp in the rear part of the machine.

⚠ ATTENTION: the ramp gradient must not be such as to cause damage to the machine as it comes down.

4. The machine is fixed to the pallet with wedges (1) that block the wheels (**Fig.1**). Remove these wedges.

5. Move to the right rear part of the machine and check that the electro-brake, present in the traction gear motor, is not engaged. Turn the lever (2) clockwise (**Fig.2**).

6. Drive the machine down the ramp.

 **ATTENTION:** during this operation, check there are no people or objects near the machine.

HOW TO MOVE THE MACHINE

To transport the machine safely, proceed as follows:

 **DANGER:** before starting any task, make sure the current regulations concerning the safe transport of dangerous substances are scrupulously observed.

1. Check to make sure that the solution tank and the recovery tank are empty. If this is not the case, empty them (see the sections titled "[EMPTYING THE SOLUTION TANK](#)" and "[EMPTYING THE RECOVERY TANK](#)").
2. Sit on the driver's seat.
3. Insert the key (3) into the main switch on the control panel. Move the main switch to position "I" (**Fig.3**) by turning the key a quarter turn clockwise.
4. Lift the brush head body and press the "BRUSH HEAD CONTROL" button (4) on the control panel (**Fig.4**).

 **N.B.:** as soon as the button (4) on the control panel is pressed, the green LED (5) ("BRUSH HEAD BODY WORK POSITION") will switch off (**Fig.4**).

5. Lift the squeegee body and press the "SQUEEGEE CONTROL" button (6) on the control panel (**Fig.4**).

 **N.B.:** as soon as the button (6) on the control panel is pressed, the green LED (7) ("SQUEEGEE BODY WORK POSITION") will switch off (**Fig.4**).

6. Press the drive pedal (8) (**Fig.5**) to begin moving the machine.
7. Use a ramp to move the machine up onto the transport vehicle.

 **CAUTION:** During this operation, check there are no people or objects near the machine.

 **N.B.:** the ramp gradient must not be such as to cause damage to the machine as it goes up.

8. Position the machine on the means of transport, and set the main switch to "0" by turning the key (3) a quarter turn anti-clockwise (**Fig.6**). Remove the key from the instrument panel.
9. Get off the machine.
10. Press the recovery tank release lever (9) and turn the recovery tank into the maintenance position (**Fig. 7**).

 **CAUTION:** the following operations must be carried out by qualified personnel. An incorrect connection of the connector may cause problems with machine functioning.

11. Disconnect the electrical connector from the machine's general system.
12. Rotate the recovery tank into the work position. Make sure that the recovery tank retainer system is correctly engaged.

 **WARNING:** secure the device according to the directives in force in the country of use, so that it cannot slide or tip over.

MACHINE SAFETY

To ensure that work is carried out in the best safety conditions, proceed as follows:

1. Make sure the solution tank is empty. If this is not the case, empty it (read "[EMPTYING THE SOLUTION TANK](#)").
2. Make sure the recovery tank is empty. If this is not the case, empty it (read "[EMPTYING THE RECOVERY TANK](#)").
3. Lift the brush head body and press the "BRUSH HEAD CONTROL" button (4) on the control panel (**Fig.4**).

 **N.B.:** as soon as the button (4) on the control panel is pressed, the green LED (5) ("BRUSH HEAD BODY WORK POSITION") will switch off (**Fig.4**).

4. Lift the squeegee body and press the "SQUEEGEE CONTROL" button (6) on the control panel (**Fig.4**).

 **N.B.:** as soon as the button (6) on the control panel is pressed, the green LED (7) ("SQUEEGEE BODY WORK POSITION") will switch off (**Fig.4**).

5. Bring the main switch to position "0" by turning the key (3) a quarter turn anti-clockwise (**Fig.6**). Remove the key from the instrument panel.
6. Get off the machine.
7. Press the recovery tank release lever (9) and turn the recovery tank into the maintenance position (**Fig. 7**).
8. Disconnect the battery connector from the machine's main system connector (**Fig.8**).
9. Rotate the recovery tank into the work position. Make sure that the recovery tank retainer system is correctly engaged (**Fig. 10**).

TYPE OF BATTERY TO BE USED

Used batteries must meet the requirements set out in DIN EN 50272-3 "Traction batteries for industrial trucks". **In order to deliver good working performance, the machine must have a power supply of 24V**; the use of two 12MFP105 batteries is recommended.

INSERTING THE BATTERIES IN THE MACHINE

To fit the batteries inside the machine, contact an FIMAP assistance centre technician.

 **WARNING:** FIMAP declines all responsibility for any damage to property or injury persons in the event that the batteries are replaced by an unauthorized technician.

BATTERY MAINTENANCE AND DISPOSAL

For battery maintenance and recharging, respect the instructions provided by the battery manufacturer. When the batteries reach the end of their service life, they must be disconnected by a FIMAP assistance centre technician or by a specialised and properly trained worker, and must be subsequently removed from the battery compartment using suitable lifting devices.

 **N.B.:** dead batteries are classified as dangerous waste and as such must be delivered to an authorised body for disposal.

RECHARGING THE BATTERIES

The batteries must be charged prior to first use, and whenever they no longer provide sufficient power to perform the desired work.

 **CAUTION:** The control board and the battery charger, if present on-board, are set for lead - acid batteries, contact the nearest FIMAP assistance centre to modify the setting if you want to use gel batteries.

 **CAUTION:** to avoid any permanent damage to the batteries, it is essential to avoid their complete discharge; begin recharging them within a few minutes of noting the "discharged batteries" signal.

 **CAUTION:** Never leave the batteries completely discharged, even if the machine is not being used.

1. Bring the machine to the battery recharging area.

 **CAUTION:** Park the machine in an enclosed place, on a flat and level surface; near the machine there must be no objects that could either damage it, or be damaged through contact with it.

 **DANGER:** the room used to recharge the batteries must be adequately ventilated to prevent the accumulation of gases that leak from batteries.

2. Perform the procedure for securing the machine (see the section titled "[SECURING THE MACHINE](#)").

3. Press the recovery tank release lever (9) and turn the recovery tank into the maintenance position (**Fig. 7**).

To recharge the batteries without the built-in battery charger, proceed as follows:

 **CAUTION:** the following operations must be carried out by qualified personnel. An incorrect connection of the connector may cause problems with machine functioning.

- Disconnect the electrical connector from the battery connector (**Fig.8**).
- Connect the external battery charger cable to the battery connector.

 **N.B.:** the coupling connector of the battery charger is consigned inside the bag containing this instruction booklet, and must be assembled on the cables of the battery charger as indicated in the instructions.

 **DANGER:** before connecting the batteries to the battery charger, make sure it is suitable for the batteries used.

 **N.B.:** carefully read the use and maintenance instructions of the battery charger that is used for charging.

- Rotate the recovery tank until the pin in the gas spring (10) is resting on the solution tank (**Fig.9**).

 **CAUTION:** keep the recovery tank open for the duration of the battery recharging cycle to allow gas fumes to escape.

- Once the recharge cycle has been completed, rotate the recovery tank to the maintenance position and disconnect the battery charger's cable from the battery connector.
- Connect the electrical system connector to the battery connector.
- Rotate the recovery tank into the working position (**Fig.10**). Make sure that the recovery tank retainer system is correctly engaged.

To recharge the batteries with the on-board battery charger proceed as follows:

 **CAUTION:** the following operations must be carried out by qualified personnel. An incorrect connection of the connector may cause problems with machine functioning.

 **N.B.:** Carefully read the use and maintenance instructions of the battery charger that is used for charging, this document is delivered along with the machine.

- Rotate the recovery tank until the pin in the gas spring (10) is resting on the solution tank (**Fig.9**).
- Remove the cap (11) from the battery charger socket (**Fig.11**).

 **CAUTION:** before connecting the batteries to the battery charger, make sure it is suitable for the batteries used.

 **WARNING:** Before inserting the battery charger power cable into the socket, verify that there is no condensate or other forms of liquids.

 **N.B.:** The charger power cable is delivered inside the bag containing this instruction booklet.

- Plug the battery charger cable into the mains socket.
- Connect the battery charger's power cable to the socket on the battery charger itself.

 **CAUTION:** keep the recovery tank open for the duration of the battery recharging cycle to allow gas fumes to escape.

- When the recharge cycle is complete, disconnect the battery charger cable from the mains.
- Disconnect the battery charger's power cable from the socket on the battery charger itself.
- Reposition the cap (11) in the socket of the battery charger (**Fig.11**).
- Rotate the recovery tank into the working position (**Fig.10**). Make sure that the recovery tank retainer system is correctly engaged.

FILLING THE SOLUTION TANK

Before filling the solution tank, carry out the following steps:

1. Take the machine to the usual place for filling the solution tank.
2. Perform the procedure for securing the machine (see the section titled "[SECURING THE MACHINE](#)").
3. Move to the front of the machine and check that the water system filter cap (12) is tightened, otherwise tighten it (**Fig.12**).

The solution tank can be filled with water in two different ways:

- Removing the cap/measuring device (13) and filling the solution tank by means of a rubber hose or a bucket (**Fig.13**).
 - Using the filler hose (14) (**Fig.14**), which supports the water hose on its own. In this case, be sure to remove the cap/measuring device (13) in order to allow the air to vent properly.
4. Fill with clean water, at a temperature no higher than 50°C (122°F) and no lower than 10°C (50°F). The amount inside the tank can be seen by means of the level tube (15) (**Fig.15**) on the left-hand side of the machine.

DETERGENT SOLUTION

For the versions without automatic detergent dosing system, after filling the solution tank with clean water, add the liquid detergent to the tank in the concentration and manner indicated on the detergent manufacturer's label.

To prevent the formation of an excessive amount of foam that could damage the vacuum motor, use the minimum percentage of detergent required.

 **CAUTION:** It is recommended to wear the appropriate PPE (Personal Protective Equipment), suitable for the work to be carried out.

 **ATTENTION:** Always use detergents whose manufacturer's label indicates their suitability for scrubbing machines. Do not use acid or alkaline products or solvents without this indication.

 **ATTENTION:** always use low-foam detergent. To avoid the production of foam, put a minimum quantity of antifoam liquid in the recovery tank before starting to clean. Do not use pure acids.

For versions with automatic detergent dosing system, fill the solution tank with clean water and then proceed as follows:

1. Take the machine to the usual place for filling the solution tank.
2. Perform the procedure for securing the machine (see the section titled "[SECURING THE MACHINE](#)").
3. Press the recovery tank release lever (9) and turn the recovery tank into the maintenance position (**Fig. 7**).
4. Disconnect the male insert (16) from the female insert (17) on the cap of the detergent canister (**Fig.16**).

 **N.B.:** before pulling on the male insert, push the lever in the female insert.

5. Grip the handle on the detergent canister (18) to remove it from the compartment in the solution tank (**Fig.17**).

6. Unscrew the cap (19) of the detergent canister (**Fig.18**).
7. Fill the canister with the required detergent, as indicated on the label of the machine.

 **CAUTION:** It is recommended to wear the appropriate PPE (Personal Protective Equipment), suitable for the work to be carried out.

 **N.B.:** always use low-foam detergent. To avoid the production of foam, put a minimum quantity of antifoam liquid in the recovery tank before starting to clean. Do not use pure acids.

 **ATTENTION:** always use detergents whose manufacturer's label indicates their suitability for scrubbing machines. Do not use acid or alkaline products or solvents without this indication.

 **ATTENTION:** the dosing system is suitable for frequent maintenance cleaning. Acid or alkaline maintenance detergent can be used with pH values between 4 and 10 and that do not contain: oxidising agents, chlorine or bromine, formaldehyde, mineral solvents. The detergents used must be suitable for use with scrubbing machines. Wash the circuit with water after use if the system is not used daily. The system can be excluded. In case of sporadic use of detergents with pH between 1-3 or 11-14, use the floor scrubbing machine in the traditional way by adding the detergent in the clean water tank and excluding the dosing circuit.

8. Ensure that you tighten the cap (19) properly to avoid any leakage of liquid while working. Make sure the detergent suction filter (20) is correctly positioned on the bottom of the canister (**Fig.19**).
9. Grip the canister handle to replace the canister in its compartment inside the solution tank.
10. Connect the male insert to the female insert in the cap of the detergent canister.
11. Rotate the recovery tank into the working position (**Fig.10**). Make sure that the recovery tank retainer system is correctly engaged.

INSERTING WATER SYSTEM FILTER

Before using the machine for the first time the water system filter needs to be reset, for shipping reasons the filter cartridge and the cap have been removed. To insert the filter cartridge in the water system filter body proceed as follows:

1. Take the machine to the maintenance area.
2. Make sure the machine has been secured (see the section titled "[SECURING THE MACHINE](#)").

 **CAUTION:** It is recommended to wear the appropriate PPE (Personal Protective Equipment), suitable for the work to be carried out.

3. Close the tap's output flow, and shift the knob (21) on the left hand side of the steering column (**Fig.20**) downward.
4. Move to the front of the machine, insert the filter cartridge (22) in the housing on the cap (12) (**Fig.21**).

 **N.B.:** The O-ring gasket in the filter cartridge should be inserted into its seat in the cap.

5. Screw the cap (12) onto the body of the detergent solution filter (23) (**Fig.22**).

FITTING THE BRUSH HEAD BRUSHES (SINGLE-BRUSH VERSION)

To fit the brush on the brush head body, proceed as follows:

1. Take the machine to the maintenance area.
2. Make sure the machine has been secured (see the section titled "[SECURING THE MACHINE](#)").

 **CAUTION:** It is recommended to wear the appropriate PPE (Personal Protective Equipment), suitable for the work to be carried out.

3. Stand on the left side of the machine.
4. With the brush head in the up position, insert the brush into the brush holder plate. Rotate the brush unit the brush's three buttons on the brush, grip with the notches in the brush plate.
5. Turn the brush in increments until the button is pushed towards the coupling spring and is locked in place (**Fig.23**).

FITTING THE BRUSH HEAD BRUSHES (DUAL-BRUSH VERSION)

To fit the brush on the brush head body, proceed as follows:

1. Take the machine to the maintenance area.
2. Make sure the machine has been secured (see the section titled "[SECURING THE MACHINE](#)").

 **CAUTION:** It is recommended to wear the appropriate PPE (Personal Protective Equipment), suitable for the work to be carried out.

3. Stand on the left side of the machine.
4. Remove the left splash guard (24), unscrew the knobs (25) on the brush head body (**Fig.24**).
5. With the brush head in the up position, insert the brush into the brush holder plate. Rotate the brush unit the brush's three buttons on the brush, grip with the notches in the brush plate.
6. Turn the brush in increments until the button is pushed towards the coupling spring and is locked in place (**Fig.25**).

7. Carry out the operations just described for the right-hand front brush as well.

i **N.B.:** The image in **Fig.25** indicates the direction of rotation for coupling the left brush; the right brush must be turned in the opposite direction.

ASSEMBLING THE ABRASIVE PAD (ORBITAL VERSION)

To fit the abrasive pad on the brush head body, proceed as follows:

1. Take the machine to the maintenance area.
2. Make sure the machine has been secured (see the section titled "[SECURING THE MACHINE](#)").

⚠ CAUTION: It is recommended to wear the appropriate PPE (Personal Protective Equipment), suitable for the work to be carried out.

3. Stand on the left side of the machine.
4. With the brush head in its raised position, insert the abrasive pad into the lodging present on the brush head body (**Fig.26**).

ASSEMBLING THE SQUEEGEE BODY

For packaging reasons, the squeegee body comes disassembled from the machine. In order to mount it on the squeegee support, do the following:

1. Make sure the machine has been secured (see the section titled "[SECURING THE MACHINE](#)").

⚠ CAUTION: It is recommended to wear the appropriate PPE (Personal Protective Equipment), suitable for the work to be carried out.

2. Unscrew the knobs (26) in the squeegee body pre-assembly (**Fig.27**).
3. First, insert the left pin (27) on the squeegee body into the left slit (28) in the squeegee support (**Fig.28**), so that the bushing adheres to the walls of the slit in the squeegee support.
4. Repeat the same operation for the right pin.
5. Insert the vacuum tube (29) in the sleeve (30) in the squeegee body (**Fig.29**).

i **N.B.:** Although the squeegee comes pre-adjusted, it is nevertheless recommended to read the section entitled "[ADJUSTING THE SQUEEGEE BODY RUBBER BLADES](#)".

PREPARING TO WORK

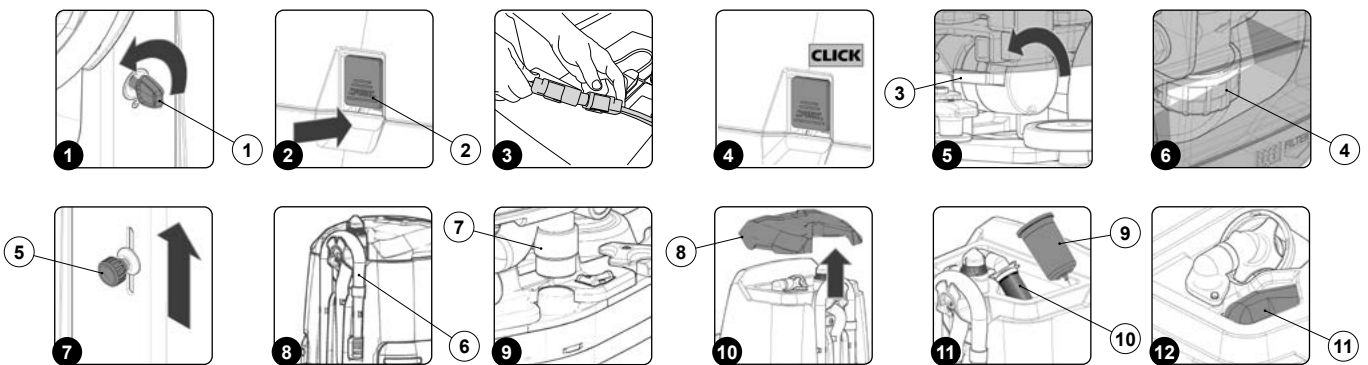

Before beginning to work, it is necessary to:

1. Make sure the recovery tank is empty. If this is not the case, empty it (read "[EMPTYING THE RECOVERY TANK](#)").
2. Check that the amount of detergent solution present in the solution tank is sufficient for the type of work to be performed. If this is not the case, top up the solution tank (see the sections titled "[FILLING THE SOLUTION TANK](#)" and "[DETERGENT SOLUTION](#)").
3. Check that the squeegee rubbers are in good working condition. If not, carry out maintenance (see "[REPLACING THE SQUEEGEE BODY RUBBER BLADES](#)").
4. Check that the condition of the brushes is suitable for the work to be carried out; if not, carry out the necessary maintenance (read the paragraphs concerning the assembly of the brushes or of the abrasive pad).
5. Check that the main switch is set to "0", turn the key (1) a quarter turn anti-clockwise (**Fig.1**). With the machine off, remove the key from the instrument panel.
6. Press the recovery tank release lever (2) and turn the recovery tank into the maintenance position (**Fig. 2**).

⚠ CAUTION: the following operations must be carried out by qualified personnel. An incorrect connection of the connector may cause problems with machine functioning.

7. Connect the battery connector from the main machine system connector (**Fig.3**).
8. Rotate the recovery tank into the working position (**Fig.4**). Make sure that the recovery tank retainer system is correctly engaged.
9. Move to the right rear part of the machine and check that the electro-brake, present in the traction gear motor, is not engaged. Turn the lever (3) clockwise (**Fig.5**).

10. Move to the front of the machine and check that the water system filter cap (4) is closed, otherwise tighten it (**Fig.6**).
11. Move to the front left-side of the machine and check that the water tap is fully open, move the water adjustment knob (5) in the direction shown by the arrow (**Fig.7**).
12. Move to the rear of the machine a check that the cap of the recovery tank drainage tube (6) is closed. If it isn't, close it (**Fig.8**).
13. Make sure the vacuum tube (7) is correctly connected to the sleeve in the squeegee body. If this is not the case, connect it (**Fig.9**).
14. Remove the recovery tank cover (8) (**Fig.10**).
15. Remove the floating guard (9) by turning it clockwise (**Fig.11**). Make sure the filter-float (10) is correctly connected and is clean, if not, clean it (see "[CLEANING THE RECOVERY TANK FILTERS](#)").
16. Make sure the filter-strainer (11) is correctly connected and is clean (**Fig.12**). If it isn't, clean it (see "[CLEANING THE RECOVERY TANK FILTERS](#)").

STARTING WORK

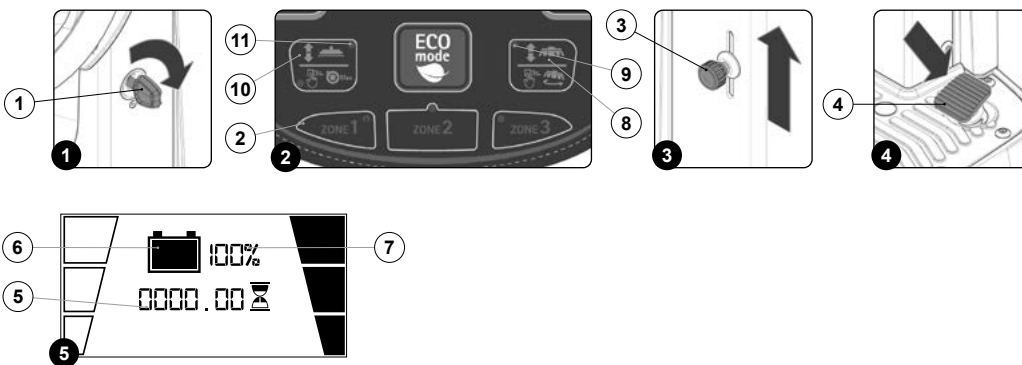

The machine can be used in the following work modes:

- ECO MODE, read the section "[ECO MODE](#)";
- MANUAL MODE, read the section "[MANUAL MODE](#)";
- PROGRAM ZONE, read the section "[PROGRAM ZONE MODE](#)".

As an example, we will look at the program mode. To begin working in this mode, proceed as follows:

1. Make all the checks listed in "[PREPARING TO WORK](#)".
2. Sit on the driver's seat.
3. Insert the key (1) into the main switch on the control panel. Set the main switch to "I" by turning the key a quarter turn clockwise (**Fig.1**).
4. Select the desired work area, press one of the three "ZONE" buttons (2) on the control panel (read paragraph "[PROGRAM ZONE MODE](#)") (**Fig.2**).
5. Open the detergent solution passage in the machine water system, move the knob (3) upwards (**Fig.3**).
6. Press the drive pedal (4) to begin moving the machine (**Fig.4**).
7. The squeegee and brush head lower until they touch the floor, as soon as the drive pedal is pressed, the traction motor, brush head motor and suction motor will start working. As a result, the solenoid valve will also be activated and detergent solution will be dispensed onto the brushes. During the first few metres, check that there is sufficient solution and that the squeegee is drying correctly.
8. The machine will now begin to work with full efficiency until the battery is flat or until the detergent solution has finished.

HOUR METER

The machine control panel contains the control display (**Fig.5**), which shows the total usage time via a series of numbers (5). The numbers before the letter "h" identify the hours, while the numbers before the letter "m" identify the tenths of an hour (a tenth of an hour corresponds to six minutes). The flashing ":" symbol indicates that the hour meter is counting the machine functioning time.

BATTERY CHARGE LEVEL INDICATOR

The command display is in the control panel (**Fig.5**); at the centre you can see the battery charge level.

The indicator is composed of two charge level symbols, the first represented by a graphic symbol (6), the second by a number that indicated the charge percentage (7). The indicator is composed of 5 charge levels, each of which represents about 20% of residual charge. With a residual charge of 20% the graphic symbol starts to flash and after a few second it will appear in larger dimensions in the middle of the screen, under these conditions take the machine to the usual place to charge the batteries

i **N.B.:** a few seconds after the battery charge level reaches 20%, the brush motor switches off automatically. With the remaining charge it is still possible, however, to complete the drying process before recharging

i **N.B.:** a few seconds after the battery charge level reaches 10%, the suction motor switches off automatically. With the remaining charge, it is still possible, however, to move the machine to the location designated for its recharging.

SCRUBBING WITH DRYING

To perform a scrubbing and drying program, proceed as follows:

1. Make all the checks listed in "[PREPARING TO WORK](#)".
2. Sit on the driver's seat.
3. Move the main switch (1) to position "I" and turn the key a quarter turn clockwise (**Fig.1**).
4. Lower the brush head body, press the "BRUSH HEAD CONTROL" button (8) on the control panel (**Fig.2**).

i **N.B.:** as soon as the button (8) on the control panel is pressed, the green LED (9) ("BRUSH HEAD BODY WORK POSITION") will switch on (**Fig.2**).

5. Lower the squeegee body and press the "SQUEEGEE CONTROL" button (10) on the control panel (**Fig.2**).

i **N.B.:** as soon as the button (10) on the control panel is pressed, the green LED (11) ("SQUEEGEE BODY WORK POSITION") will switch on (**Fig.2**).

6. Press the drive pedal (4) to begin moving the machine (**Fig.4**).

i **N.B.:** Once the drive pedal has been pressed, the brush head body will begin to descend into its working position.

i **N.B.:** the gearmotor will only begin functioning, and the solenoid valve will only begin dispensing detergent solution, when the brush head body is in its working position.

SCRUBBING WITHOUT DRYING

To perform a scrubbing program without drying , proceed as follows:

1. Make all the checks listed in "[PREPARING TO WORK](#)".
2. Sit on the driver's seat.
3. Move the main switch (1) to position "I" and turn the key a quarter turn clockwise (**Fig.1**).
4. Lower the brush head body, press the "BRUSH HEAD CONTROL" button (8) on the control panel (**Fig.2**).

i **N.B.:** as soon as the button (8) on the control panel is pressed, the green LED (9) ("BRUSH HEAD BODY WORK POSITION") will switch on (**Fig.2**).

5. Press the drive pedal (4) to begin moving the machine (**Fig.4**).

i **N.B.:** Once the drive pedal has been pressed, the brush head body will begin to descend into its working position.

i **N.B.:** the gearmotor will only begin functioning, and the solenoid valve will only begin dispensing detergent solution, when the brush head body is in its working position.

DRYING

To perform a drying only program, proceed as follows:

1. Make all the checks listed in "[PREPARING TO WORK](#)".
2. Sit on the driver's seat.
3. Move the main switch (1) to position "I" and turn the key a quarter turn clockwise (**Fig.1**).
4. Lower the squeegee body and press the "SQUEEGEE CONTROL" button (10) on the control panel (**Fig.2**).

i **N.B.:** as soon as the button (10) on the control panel is pressed, the green LED (11) ("SQUEEGEE BODY WORK POSITION") will switch on (**Fig.2**).

5. Press the drive pedal (4) to begin moving the machine (**Fig.4**).



ATTENTION: The drying without scrubbing operation should only be carried out if the device was used beforehand to carry out a scrubbing without drying operation.

OVERFLOW DEVICE

The standard model machine is NOT equipped with an overflow device, because the volume of the recovery tank is larger than the capacity of the solution tank. In extraordinary cases, there is a mechanical device (float) under the recovery tank lid that, when the recovery tank is full, shuts off the air to the vacuum motor intake to protect it; the sound of the suction motor will then be deeper. Empty the recovery tank (see "[EMPTYING THE RECOVERY TANK](#)").

ADDITIONAL FUNCTIONS

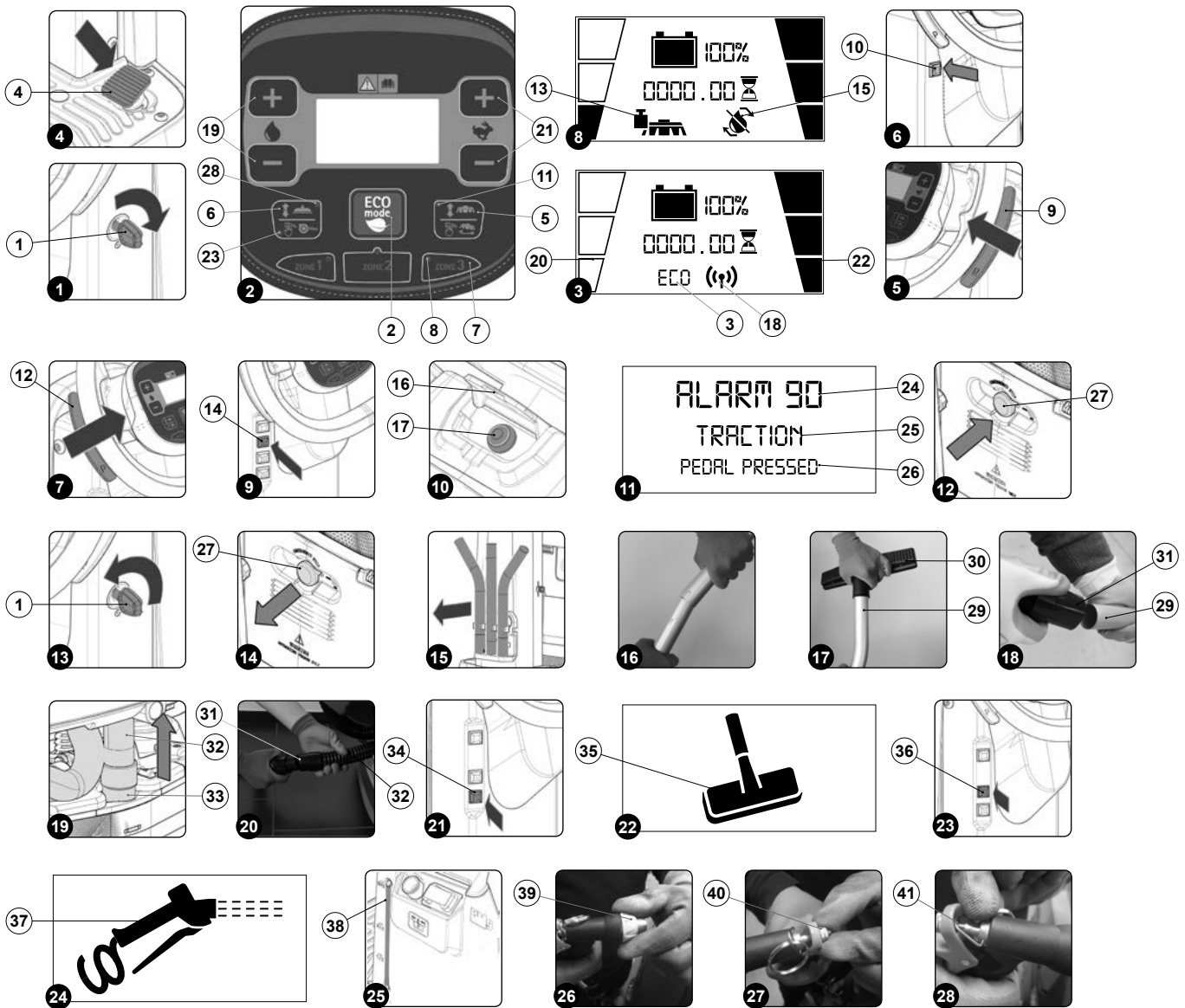

ECO MODE

At the centre of the control panel is the ECO MODE button; pressing this will activate "ECO MODE", a program which guarantees the best possible performance in terms of consumption and cleaning. To activate the ECO MODE program, proceed as follows:

1. Sit on the driver's seat.
2. Insert the key (1) into the main switch on the control panel. Set the main switch to "I" by turning the key a quarter turn clockwise (Fig.1).
3. Select the ECO MODE working program with the button (2) at the centre of the control panel (Fig.2).

i N.B.: As soon as the button (2) in the control display is pressed, the "ECO-MODE ACTIVE" symbol (3) will appear (Fig.3).

4. Press the drive pedal (4) to begin moving the machine (Fig.4).

i N.B.: to activate the ECO MODE function, with the transfer working program active, you can also press the "BRUSH HEAD CONTROL" button (5) or the "SQUEEGEE CONTROL" button (6) (Fig.2). Pressing one of the two buttons will switch from the transfer program to the relative program selected, and the symbol (3) will appear in the control display.

MANUAL MODE

To change from the "ECO MODE" or from the "PROGRAM ZONE" mode to the "MANUAL MODE", simply change one of the following parameters:

1. Quantity of detergent solution present in the machine's water system (read paragraph "[ADJUSTMENT OF THE DETERGENT SOLUTION FLOW](#)").
2. Machine's forward speed level (read paragraph "[REGULATING THE FORWARD SPEED](#)").
3. Suction motor performance level (read paragraph "[SILENT FUNCTION](#)").
4. Pressure level exerted on the brush head (read paragraph "[EXTRA BRUSH HEAD PRESSURE FUNCTION](#)").

 **N.B.:** When the "MANUAL MODE" is active in the control display the symbol (1) relative to the "ECO MODE ACTIVE" function will disappear.(Fig.1).

PROGRAM ZONE MODE

The "PROGRAM ZONE" modes foresees the use of three functions already stored in the machine's internal memory, levels:

- Forward speed
- Adjustment of the detergent solution flow
- Suction motor efficiency

are pre-set and have been created on the basis of the type of environment where you want to work.

To select an area program, just press the relative button (7) on the control panel (Fig.2).

 **N.B.:** when an area program is active, the relative LED (8) will light up on the control panel (Fig.2).

 **N.B.:** if you want to change the levels of the above parameters of the "AREA" functions, just make the necessary modifications then press and hold the button of the relative program for about three seconds. The modification will be recorded when the LED starts flashing.

REVERSE FUNCTION

This machine is equipped with electronic traction control. To reverse, proceed as follows:

1. Engage the "REVERSE GEAR ACTIVATION/DEACTIVATION" lever (9) underneath the steering wheel (Fig.5).
2. Press the drive pedal (4) (Fig.4); in this manner the machine will begin to move in reverse.

 **CAUTION:** the reverse speed is lower than the forward speed to comply with current health and safety standards.

 **N.B.:** In order to disengage the reverse gear, disengage the lever (9) underneath the steering wheel (Fig.5).

 **N.B.:** Once the lever has been engaged (9), the acoustic signalling device will be activated in order to signal that the machine's reverse gear has been engaged.

 **N.B.:** If the reverse gear is engaged with the squeegee in its working position, once the drive pedal is pressed, the machine will begin to move in reverse and the squeegee body will be raised into its resting position.

 **N.B.:** If the reverse gear is engaged with the brush head in its working position, once the drive pedal is pressed, the machine will begin to move in reverse and the brush head will remain in its working position, but the solenoid valve will stop dispensing detergent solution to the brushes.

BUZZER

The machine is equipped with a buzzer. if you need to sound a warning, just press the button (10) on the steering column (Fig.6).

EXTRA BRUSH HEAD PRESSURE FUNCTION

This machine can increase the pressure exerted on the brush during the work cycle. To do this:

1. Make sure the brush head body is in contact with the floor. If this is not the case, press the "BRUSH HEAD CONTROL" button (5) on the control panel (Fig.2).

 **N.B.:** as soon as the button (5) on the control panel is pressed, the green LED (11) ("BRUSH HEAD BODY WORK POSITION") will switch on (Fig.2).

2. Engage the "EXTRA-PRESSURE ACTIVATION/DEACTIVATION" lever (12) underneath the steering wheel (Fig.7).

 **N.B.:** As soon as you move the lever (12) in the control display panel the symbol (13) "EXTRA BRUSH HEAD PRESSURE ACTIVE" will appear (Fig.8).

- i** **N.B.:** To deactivate the function, move the lever (12) again, the symbol (13) in the control display panel will disappear.

DETERGENT SOLUTION RECYCLING SYSTEM

Upon request the machine can be fitted with a system that allows the detergent solution to be recycled so that productivity can be increased, since the number of stops needed to empty and fill the tanks is reduced.

As a result less water and detergent are used, thereby making the operator safer, who comes into contact with the chemical products less frequently, and the operation is more environmentally friendly.

To start it do as follows.

1. With the machine running, press the FLR SYSTEM ACTIVATION/DEACTIVATION button (14) (**Fig.9**).

- i** **N.B.:** if the LED on the button (14) is on, the FLR system is active; if the LED is off, the FLR system is deactivated.

- i** **N.B.:** the FLR system activates when the electric pump in the machine's water system starts.

- i** **N.B.:** if you want to deactivate the FLR system press button (14) again.

2. The machine will continue working until there is no more any detergent solution in both tanks.

- i** **N.B.:** if the detergent solution in both tanks should run out, the symbol (15) "FLR SYSTEM NOT WORKING" will appear in the control display (**Fig.8**). Deactivate the function using the button (14) and fill the solution tank with a new detergent solution.

AUTOMATIC REQUEST FOR TECHNICAL ASSISTANCE (FFM VERSIONS)

The machine with incorporated FFM system has an automatic service for activating an urgent technical assistance request. To activate this function, the operator must press the button (17) under the hatch (16) bearing the symbol "SOS" (**Fig. 10**).

- i** **N.B.:** in order to activate this urgent technical assistance request the machine needs to be equipped with the FIMAP FLEET MANAGEMENT kit.

- i** **N.B.:** in order to send a technical assistance request the machine needs to be on and should be in a zone with data traffic coverage.

- i** **N.B.:** when the connection between the function board and the FFM board is active, the control display will show the connection symbol (18) (**Fig.3**).

AUTOMATIC DETERGENT DOSING SYSTEM (FSS VERSIONS)

Upon request, the machine can be fitted with a system that measures out the detergent separately from the water in the solution tank. To activate it, with the machine running, press the FSS SYSTEM ACTIVATION/DEACTIVATION button (14) (**Fig.9**).

- i** **N.B.:** if the LED on the button (14) is on, the FSS system is active; if the LED is off, the FSS system is deactivated.

- i** **N.B.:** the FSS system activates when the electric pump in the machine's water system starts.

- i** **N.B.:** if you want to deactivate the FSS system press button (14) again.

- i** **N.B.:** the amount of detergent present in the washing solution dispensed by the machine is proportional (in a percentage defined by a pre-set parameter in the machine) to the water flow rate present in the water circuit of the machine.

ADJUSTMENT OF THE DETERGENT SOLUTION FLOW

To adjust the flow of detergent solution during work, proceed as follows:

1. During the first few working meters check that the amount of solution is sufficient to wet the floor, but not excessive to exit the splash guard.
2. If the amount of solution that comes out is not right, use the "+" and "-" buttons (19) on the control panel to adjust it (**Fig.2**).

- i** **N.B.:** the flow of detergent solution onto the brush can be adjusted to four levels, from 0 to 3. The level can be seen with the symbol (20) on the control display (**Fig.3**).

- i** **N.B.:** If the flow is set to 0, there is no emission of detergent solution.

REGULATING THE FORWARD SPEED

To adjust the flow of detergent solution during work, proceed as follows:

1. During the first few metres, check that the forward speed is adequate to the grip conditions.
2. If the forward speed is not suitable, you can adjust this using the “+” and “-” buttons (21) on the control panel (**Fig.2**).

i **N.B.:** The forward speed can be adjusted to three levels from 1 to 3. The level can be seen with the symbol (22) on the control display (**Fig. 3**).

i **N.B.:** The forward speed of the machine can also be adjusted by regulating the potentiometer in the drive pedal. To do this, press the pedal (4) (**Fig.4**) to the required degree. The more you press, the higher the speed (within the limits of the level selected beforehand).

SILENT FUNCTION

This machine has a SILENT function for reducing the noise generated by the suction motor. The silent function is always active in the machine as a default. To deactivate the silent function, press the button (6) on the instrument panel for at least three seconds (**Fig.2**).

i **N.B.:** when the silent-max function is active, the relative LED (23) will light up on the control panel (**Fig.2**).

ALARM SCREEN

When an error occurs, the corresponding alarm screen will appear on the control display.

The display of the alarm consists of a first flashing line relating to the code (24) and the source of the error (25), while the second line displays a summary (26) of the error description (**Fig.11**).

The alarm screen will remain visible until the error is resolved.

When an error occurs, do as follows:

1. Stop the machine immediately.
2. If the error persists, switch off the machine, wait for at least ten seconds and switch on the machine.
3. If the error persists contact the nearest service centre.

EMERGENCY BUTTON

If any serious problems are encountered during the work operations, press the emergency button (27) on the electrical system's carter (**Fig.12**).

! **CAUTION:** This command interrupts the electrical circuit between the batteries and the machine system.

i **N.B.:** After having stopped and resolved the problem, the work operations can be resumed by doing the following:

- Set the main switch to “0”, turn the key (1) a quarter turn anti-clockwise (**Fig. 13**).
- Move the mushroom-head emergency button forwards (27) (**Fig.14**).
- Move the main switch to position “I” and turn the key (1) a quarter turn clockwise (**Fig.1**).

LIQUID SUCTION WAND KIT

Upon request, the machine can be fitted with the VACUUM WAND system that vacuums up the detergent solution more accurately. To start it do as follows.

1. Lift the brush head body, press the “BRUSH HEAD COMMAND” button (5) on the control panel (**Fig.2**).

i **N.B.:** As soon as the button (5) on the control panel is pressed, the green LED (11) (“BRUSH HEAD BODY WORK POSITION”) will switch off (**Fig.2**).

2. Lift the squeegee body and press the “SQUEEGEE CONTROL” button (6) on the control panel (**Fig.2**).

i **N.B.:** as soon as the button (6) on the control panel is pressed, the green LED (28) (“SQUEEGEE BODY WORK POSITION”) will switch off (**Fig.2**).

3. Remove all the vacuum kit components from the storage compartment (**Fig.15**).
4. Assemble the steel extension tubes (**Fig.16**).
5. Insert the vacuum brush (30) into the extension tube (29) (**Fig.17**).
6. Connect the vacuum tube (31) to the extension tube (29) (**Fig.18**).
7. Remove the vacuum tube (32) from the sleeve (33) in the squeegee body (**Fig.19**).
8. Connect the wand kit vacuum tube (31) to the squeegee vacuum tube (32) (**Fig.20**).
9. Activate the vacuum control kit by pressing the button (34); this is located to the rear of the steering column (**Fig.21**).

i **N.B.:** As soon as the button (34) is pressed, the LED on it will light up (**Fig.21**).

i **N.B.:** As soon as the button (34) on the control display is pressed, the symbol (35) will appear (**Fig.22**).

! **WARNING:** never pick up solid matter such as dust, cigarette stubs, paper, etc.

! **CAUTION:** Never collect gases, explosive/inflammable liquids or powders, nor acids and solvents! These include gasoline, paint thinners and fuel oil (which, when mixed with the vacuum air, can form explosive vapours or mixtures), and also non-diluted acids and solvents, acetones, aluminium and magnesium powders. These substances may also corrode the materials used to construct the machine.

! **CAUTION:** if the machine is used in dangerous areas (e.g. petrol stations), the relative safety standards must be observed. It is forbidden to use the machine in environments with a potentially explosive atmosphere.

10. When the work is finished, remove the kit and place it in the storage compartment.

SPRAY GUN KIT

On request, the machine can be equipped with the spray gun kit. To use this, proceed as follows:

1. Lift the brush head body, press the "BRUSH HEAD COMMAND" button (5) on the control panel (**Fig.2**).

i **N.B.:** As soon as the button (5) on the control panel is pressed, the green LED (11) ("BRUSH HEAD BODY WORK POSITION") will switch off (**Fig.2**).

2. Lift the squeegee body and press the "SQUEEGEE CONTROL" button (6) on the control panel (**Fig.2**).

i **N.B.:** as soon as the button (6) on the control panel is pressed, the green LED (28) ("SQUEEGEE BODY WORK POSITION") will switch off (**Fig.2**).

3. Release the spray gun accessory (at the back of the machine) from the retainers.

4. Activate the vacuum control kit by pressing the button (36); this is located to the rear of the steering column (**Fig.23**).

i **N.B.:** As soon as the button (36) is pressed, the LED on it will light up (**Fig.23**).

i **N.B.:** As soon as the button (36) on the control display is pressed, the symbol for the spray gun kit (37) will appear (**Fig.24**).

i **N.B.:** With the spray gun kit active, the traction and work functions are deactivated.

! **CAUTION:** It is recommended to wear the appropriate PPE (Personal Protective Equipment), suitable for the work to be carried out.

i **N.B.:** Before using the optional tank cleaning kit, check the level indicator (38) to see how much solution there is in the solution tank (**Fig.25**).

5. Activate the solution jet by pressing the lever in the tank cleaning accessory. Make sure the jet is pointing into the tank before pressing the lever.

i **N.B.:** To adjust the solution jet from the tank cleaning accessory, turn the knob (39) on the accessory itself (**Fig.26**).

i **N.B.:** To adjust the intensity of the solution jet from the tank cleaning accessory, turn the knob (40) on the accessory itself (**Fig.27**).

i **N.B.:** To stop the solution jet, use the lever (41) on the tank cleaning accessory (**Fig.28**).

AT THE END OF THE WORK

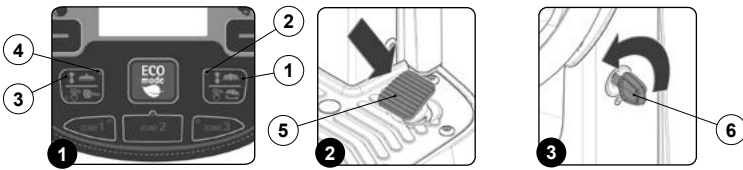

At the end of the work, and before carrying out any type of maintenance, perform the following operations:

1. Lift the brush head body and press the “BRUSH HEAD CONTROL” button (1) on the control panel (**Fig.1**).

i **N.B.:** as soon as the button (1) on the control panel is pressed, the green LED (2) (“BRUSH HEAD BODY WORK POSITION”) will switch off (**Fig.1**).

2. Lift the squeegee body and press the “SQUEEGEE CONTROL” button (2) on the control panel (**Fig.1**).

i **N.B.:** as soon as the button (2) on the control panel is pressed, the green LED (3) (“SQUEEGEE BODY WORK POSITION”) will switch off (**Fig.1**).

3. Press the drive pedal (4) (**Fig.3**) to begin moving the machine.
4. Take the appliance to the dedicated dirty water drainage area.
5. Switch off the machine by turning the key (5) of the main switch a quarter turn anti-clockwise (**Fig.4**). Remove the key from the instrument panel.
6. Carry out all the procedures listed in “RECOMMENDED PERIODIC MAINTENANCE” (in the “AT THE END OF THE WORK” column).
7. Once the routine maintenance operations have been completed, take the machine to the area designated for storage.

! **ATTENTION:** Park the machine in an enclosed place, on a flat surface, and at a safe distance from any objects that could either damage it or be damaged due to contact with the machine itself.

8. Secure the machine, see the section titled “[SECURING THE MACHINE](#)”.

ROUTINE MAINTENANCE

Before carrying out any routine maintenance operations, proceed as follows:

1. Take the machine to the maintenance area.

♻️ **N.B.:** the place given over to this operation must comply with current environmental protection regulations.

2. Make sure the machine is in a safe condition (see chapter “[MACHINE SAFETY MEASURES](#)”).

! **CAUTION:** it is recommended to wear the appropriate PPE (Personal Protective Equipment), suitable for the work to be carried out.

TYPE OF MAINTENANCE	AT THE END OF THE WORK	DAILY	WEEKLY	BEFORE A LONG PERIOD OF NON-USE	TRANSPORT
DRAINING THE RECOVERY TANK	X			X	X
CLEANING THE SQUEEGEE BODY	X	X		X	
CLEANING BRUSH HEAD BRUSHES (SCRUBBING)		X		X	
CLEANING THE RECOVERY TANK FILTERS		X		X	
CLEANING THE RECOVERY TANK		X		X	
EMPTYING THE SOLUTION TANK		X		X	X
CLEANING THE WATER SYSTEM FILTER		X		X	
CLEANING THE VACUUM TUBE		X		X	

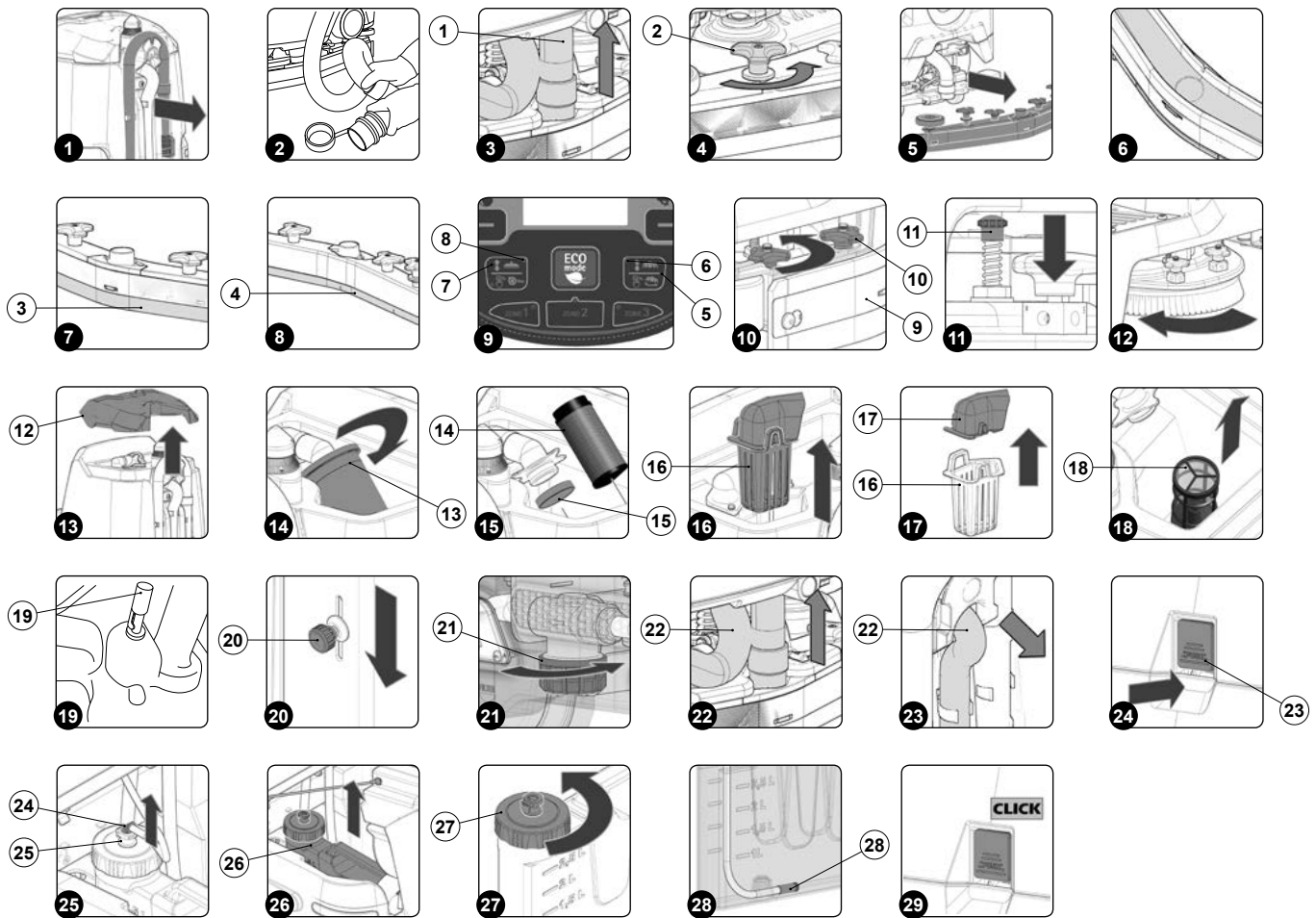

DRAINING THE RECOVERY TANK

Proceed as follows to empty the recovery tank:

1. Remove the drainage hose of the recovery tank from the clamps; it is located at the rear of the machine (**Fig.1**).
2. Bend the end of the drainage tube in order to create a choke and prevent the content from coming out (**Fig.2**), then position the tube on the discharge surface, unscrew the cap, and gradually release the tube.



N.B.: The place given over to this operation must comply with current environmental protection regulations.

3. Repeat the operations in reverse order to reassemble all the parts.

CLEANING THE SQUEEGEE BODY

The careful cleaning of the whole vacuum unit ensures better drying and cleaning of the floor as well as a longer suction motor life. To carry out the cleaning of the squeegee body, proceed as follows:

1. Extract the vacuum hose (1) from the vacuum nozzle on the squeegee body (**Fig.3**).
2. Completely unscrew the knobs (2) on the squeegee body pre-assembly (**Fig.4**).
3. Remove the squeegee unit from the slits in the squeegee connector (**Fig.5**).
4. Thoroughly clean the squeegee body vacuum chamber (4) with a jet of water, and then with a damp cloth (**Fig.6**).
5. Thoroughly clean the squeegee body's rear rubber blade (5) with a jet of water, and then with a damp cloth (**Fig.7**).
6. Thoroughly clean the squeegee body front rubber blade (6) with a jet of water, and then with a damp cloth (**Fig.8**).
7. Thoroughly clean the vacuum nozzle with a jet of water, and then with a damp cloth.
8. Proceed in the opposite order to reassemble all the parts.

CLEANING THE BRUSH HEAD BRUSH (SINGLE BRUSH VERSION)

Careful cleaning of the brush guarantees better cleaning of the floor as well as a longer brush head gearmotor lifespan. To clean the brush, proceed as follows:

1. Lift the brush head body, press the "BRUSH HEAD COMMAND" button (5) on the control panel (**Fig.9**).



N.B.: As soon as the button (5) on the control panel is pressed, the green LED (6) ("BRUSH HEAD BODY WORK POSITION") will switch off (**Fig.9**).

- Lift the squeegee body and press the “SQUEEGEE CONTROL” button (7) on the control panel (**Fig.9**).

i **N.B.:** as soon as the button (7) on the control panel is pressed, the green LED (8) (“SQUEEGEE BODY WORK POSITION”) will switch off (**Fig.9**).

- When the brush head body is in the rest position, raised from the ground, press the “BRUSH HEAD CONTROL” button (5) present on the command panel for at least 3 seconds (**Fig.9**).
- Clean the brush under a stream of running water to remove any impurities from its bristles. Check the wear status of the bristles and replace the brushes if they are excessively consumed (the bristles' protrusion must not be less than 10 mm; this distance is indicated on the brush by the yellow band). Read the paragraph [“ASSEMBLING THE BRUSH HEAD BRUSH \(SINGLE-BRUSH VERSION\)”](#) when replacing the brush.
- After checking to make sure that the brush is clean, reassemble it.

CLEANING THE BRUSH HEAD BRUSHES (DUAL-BRUSH VERSION)

Careful cleaning of the brush guarantees better cleaning of the floor as well as a longer brush head gearmotor lifespan. To clean the brush, proceed as follows:

- Move to the left side of the machine and remove the left splash guard (9); first remember to completely unscrew the knobs (10) present on the brush head body (**Fig.10**).
- Press the brush locking pin (11) (**Fig.11**).
- Keeping the pin (11) pressed, turn the brush clockwise until it is released (**Fig.12**).
- Turn until the button is pushed towards the outside of the coupling spring and is locked into place.
- Clean the brush under a stream of running water to remove any impurities from its bristles. Check the wear status of the bristles and replace the brushes if they are excessively consumed (the bristles' protrusion must not be less than 10 mm; this distance is indicated on the brush by the yellow band). Read the paragraph [“ASSEMBLING THE BRUSH HEAD BRUSH \(DUAL-BRUSH VERSION\)”](#) when replacing the brushes.
- After checking to make sure that the brush is clean, reassemble it and move on to the one on the right hand side.

i **N.B.:** you are advised to invert the right and left-hand brushes every day.

i **N.B.:** The image in **Fig.12** indicates the direction of rotation for uncoupling the left brush; the right brush must be turned in the opposite direction.

⚠ **ATTENTION:** If the brushes are not new however, and have deformed bristles, it is better to reassemble them in the same position (the right-hand one on the right, and the left-hand one on the left), to prevent the different inclination of the bristles producing an overload on the brush motor as well as excessive vibrations.

CLEANING THE RECOVERY TANK FILTERS

In order to clean the filters present inside the recovery tank, do the following:

- Stand at the back of the machine.
- Remove the recovery tank cover (12) (**Fig.13**).
- Remove the float protection (13) by rotating it in the direction indicated by the arrow, and clean it under running water (**Fig.14**).

i **N.B.:** Use a spatula or brush to eliminate any dirt that is particularly difficult to remove.

- Having firstly removed the fastening clamp (15), remove the suction motor filter (14) from the support and clean it under running water (**Fig.15**).

i **N.B.:** Use a spatula or brush to eliminate any dirt that is particularly difficult to remove.

- Remove the dirty water basket/filter from the support (16) (**Fig.16**).
- Remove the basket cover (17) from the basket/filter (16) (**Fig.17**).
- Clean the basket/filter (16) and the basket cover (17) under a jet of water.

i **N.B.:** Use a spatula or brush to eliminate any dirt that is particularly difficult to remove.

- When all the components that have just been washed are dry, carry out the operations just described in reverse to insert them into the machine.

CLEANING THE RECYCLE FILTER (FLR VERSIONS)

Proceed as follows to empty the recovery tank:

- Stand at the back of the machine.
- Remove the recovery tank cover (12) (**Fig.13**).
- Remove the float protection (13) by turning it in the direction indicated by the arrow (**Fig.14**).
- Having first removed the fastening clamp (15), remove the suction motor filter (14) from the support (**Fig.15**).
- Remove the sediment filter (18) from the support and clean it under running water (**Fig. 18**).

i N.B.: Use a spatula or brush to eliminate any dirt that is particularly difficult to remove.

6. Rinse the inside of the recovery tank with a jet of water. If necessary, use a spatula to remove any sludge that may have accumulated at the bottom of the tank.

! WARNING: Be sure to also clean the electro-mechanical float (19) inside the tank (**Fig.19**).

7. Repeat the operations in reverse order to reassemble all the parts.

EMPTYING THE SOLUTION TANK

Proceed as follows to empty the solution tank:

1. Close the tap's output flow, and shift the knob (20) on the left hand side of the steering column (**Fig.20**) downward.
2. Remove the detergent solution filter cap (21) (**Fig.21**).
3. Open the tap's output flow, and shift the knob (20) on the left hand side of the steering column upward.
4. When the solution tank is empty, repeat the operations in the reverse order to reassemble all the parts.

CLEANING THE WATER SYSTEM FILTER

In order to clean the water system's filter, do the following:

1. Close the tap's output flow, and shift the knob (20) on the left hand side of the steering column (**Fig.20**) downward.
2. Remove the detergent solution filter cap (21) (**Fig.21**).
3. Rinse the filter cartridge under a jet of water, and use a brush to eliminate any impurities, if necessary.
4. Once the filter cartridge is clean, repeat the operations in the opposite order to reassemble all the parts.

CLEANING THE VACUUM TUBE

Careful cleaning of the vacuum hose guarantees better cleaning of the floor as well as a longer suction motor life. Proceed as follows to clean the vacuum hose:

1. Extract the vacuum tube (22) from the vacuum nozzle on the squeegee body (**Fig.1**).
2. Remove the vacuum tube (22) via the hole on the back of the recovery tank (**Fig.2**).
3. The vacuum hose from the retainers present inside the recovery tank.
4. Rinse the inside of the vacuum hose with a jet of running water.
5. Repeat the operations in reverse order to reassemble all the parts.

CLEANING THE DETERGENT TANK (FSS VERSIONS)

Clean the detergent tank before a long period of non-use of the machine:

1. Press the recovery tank release lever (23) and turn the recovery tank into the maintenance position (**Fig. 24**).
2. Disconnect the male insert (24) from the female insert (25) on the cap of the detergent canister (**Fig.25**).

i N.B.: before pulling on the male insert, push the lever on the female insert.

3. Grip the handle on the detergent canister (26) to remove it from the compartment in the solution tank (**Fig.26**).
4. Remove the cap (27) from the detergent canister (**Fig.27**).
5. Rinse the inside of the canister with a jet of running water.
6. Ensure that you tighten the cap (27) properly to avoid any leakage of liquid while working. Make sure the detergent suction filter (28) is correctly positioned on the bottom of the canister (**Fig.28**).
7. Grip the canister handle to replace the canister in its compartment inside the solution tank.
8. Connect the male insert to the female insert in the cap of the detergent canister.
9. Rotate the recovery tank into the working position (**Fig.29**). Make sure that the recovery tank retainer system is correctly engaged.

EXTRAORDINARY MAINTENANCE

Before carrying out any extraordinary maintenance operations, proceed as follows:

1. Take the machine to the maintenance area.



N.B.: the place given over to this operation must comply with current environmental protection regulations.

2. Make sure the machine is in a safe condition (see chapter "[MACHINE SAFETY MEASURES](#)").



CAUTION: it is recommended to wear the appropriate PPE (Personal Protective Equipment), suitable for the work to be carried out.

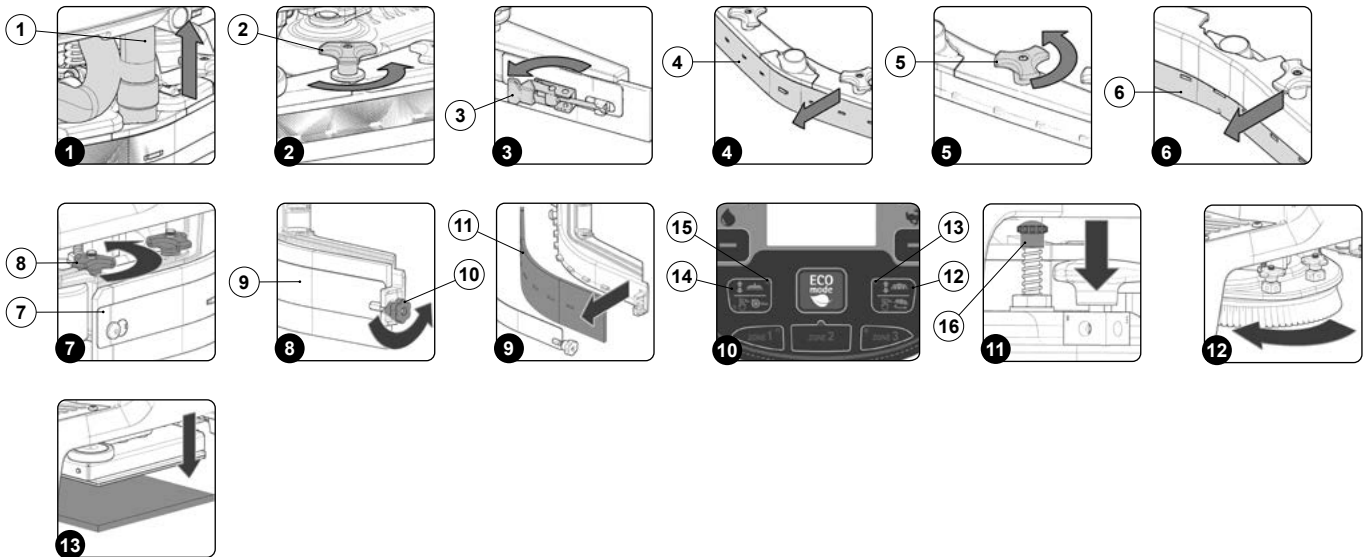

REPLACING THE SQUEEGEE BODY RUBBER BLADES

Ensuring the integrity of the squeegee body's rubber blades guarantees better floor cleaning and drying results, as well as a longer service life for the suction motor. In order to replace the squeegee body's rubber blades, do the following:

1. Extract the vacuum hose (1) from the vacuum nozzle on the squeegee body (Fig.1).
2. Completely unscrew the knobs (2) in the squeegee body's pre-assembly (Fig.2).
3. Remove the squeegee body from the slits in the squeegee connector.
4. Remove the rear rubber blade compression plate, and release the stopper (3) at the rear of the squeegee (Fig. 3).
5. Remove the rear rubber blade (4) from the squeegee body (Fig. 4).
6. Completely unscrew the knobs (5) in the squeegee body pre-assembly (Fig.5).
7. Remove the front rubber blade (6) from the squeegee's internal body (Fig. 6).
8. Repeat the operations in reverse order to reassemble all the parts.



N.B.: Before using the machine, remember to adjust the squeegee body: see the section titled "[ADJUSTING THE SQUEEGEE BODY'S RUBBER BLADES](#)".



N.B.: It is recommended to replace both squeegee body blades in order to ensure good results when drying the floor.

REPLACING THE BRUSH HEAD SPLASH GUARD

If the splash guard rubber blades of the brush head side casing are damaged they cannot work properly, namely they cannot convey the dirty detergent solution towards the squeegee, therefore the splash guard rubber blades need to be checked. To replace the brush head splash guards, proceed as follows:

1. Stand on the left side of the machine.
2. Remove the left splash guard (7), unscrew the knobs (8) on the brush head body (Fig.7).
3. Remove the rear rubber blade compression plate (9), and release the stopper (10) on rubber blade compression plate (Fig.8).
4. Remove the splash guards (11) from the left splash guard body and replace it with a new one or else turn it around (Fig.9).
5. Repeat the operations in reverse order to reassemble all the parts.
6. Repeat the operations just carried out also for the right side casing as well.

REPLACING THE BRUSH HEAD BRUSH (SINGLE BRUSH VERSION)

Ensuring the integrity of the brush will guarantee better floor cleaning results, and will extend the service life of the brush head's gearmotor. To replace the brush, proceed as follows:

1. Lift the brush head body, press the "BRUSH HEAD COMMAND" button (12) on the control panel (**Fig.10**).
 - i** **N.B.:** As soon as the button (12) on the control panel is pressed, the green LED (13) ("BRUSH HEAD BODY WORK POSITION") will switch off (**Fig.10**).
2. Lift the squeegee body and press the "SQUEEGEE CONTROL" button (14) on the control panel (**Fig.11**).
 - i** **N.B.:** as soon as the button (14) on the control panel is pressed, the green LED (15) ("SQUEEGEE BODY WORK POSITION") will switch off (**Fig.11**).
3. When both the squeegee body and the brush head body are in the rest position, raised from the ground, press the "BRUSH HEAD CONTROL" button (12) present on the command panel for at least 3 seconds (**Fig.10**).
4. Read the paragraph "[ASSEMBLING THE BRUSH HEAD BRUSH \(SINGLE-BRUSH VERSION\)](#)" when replacing the brush.

REPLACING THE BRUSH HEAD BRUSHES (DUAL BRUSH VERSION)

Ensuring the integrity of the brush will guarantee better floor cleaning results, and will extend the service life of the brush head's gearmotor. To replace the brush, proceed as follows:

1. Move to the left side of the machine and remove the left splash guard (7); first remember to completely unscrew the knobs (8) present on the brush head body (**Fig.7**).
2. Press the brush locking pin (16) (**Fig.11**).
3. Keeping the pin (16) pressed, turn the brush clockwise until it is released (**Fig.12**).
4. Turn until the button is pushed towards the outside of the coupling spring and is locked into place.
5. Read the paragraph "[ASSEMBLING THE BRUSH HEAD BRUSH \(DUAL-BRUSH VERSION\)](#)" when replacing the brushes.

REPLACING THE ABRASIVE PAD (ORBITAL VERSION)

Ensuring the good condition of the abrasive pad will guarantee better floor cleaning results, and will extend the service life of the brush head motor. To replace the abrasive pad, proceed as follows:

1. Lift the brush head body, press the "BRUSH HEAD COMMAND" button (12) on the control panel (**Fig.10**).
 - i** **N.B.:** As soon as the button (12) on the control panel is pressed, the green LED (13) ("BRUSH HEAD BODY WORK POSITION") will switch off (**Fig.10**).
2. Lift the squeegee body and press the "SQUEEGEE CONTROL" button (14) on the control panel (**Fig.11**).
 - i** **N.B.:** as soon as the button (14) on the control panel is pressed, the green LED (15) ("SQUEEGEE BODY WORK POSITION") will switch off (**Fig.11**).
3. When both the squeegee body and the brush head body are in the rest position, raised from the ground, climb down from the machine and remove the worn abrasive pad (**Fig.13**).
4. Read the section "[ASSEMBLING THE ABRASIVE PAD \(ORBITAL VERSION\)](#)" for information on fitting a new abrasive pad.

ADJUSTMENT INTERVENTIONS

Before carrying out any adjustments, proceed as follows:

1. Take the machine to the maintenance area.

 **N.B.:** the place given over to this operation must comply with current environmental protection regulations.

2. Make sure the machine is in a safe condition (see chapter "[MACHINE SAFETY MEASURES](#)").

 **CAUTION:** it is recommended to wear the appropriate PPE (Personal Protective Equipment), suitable for the work to be carried out.

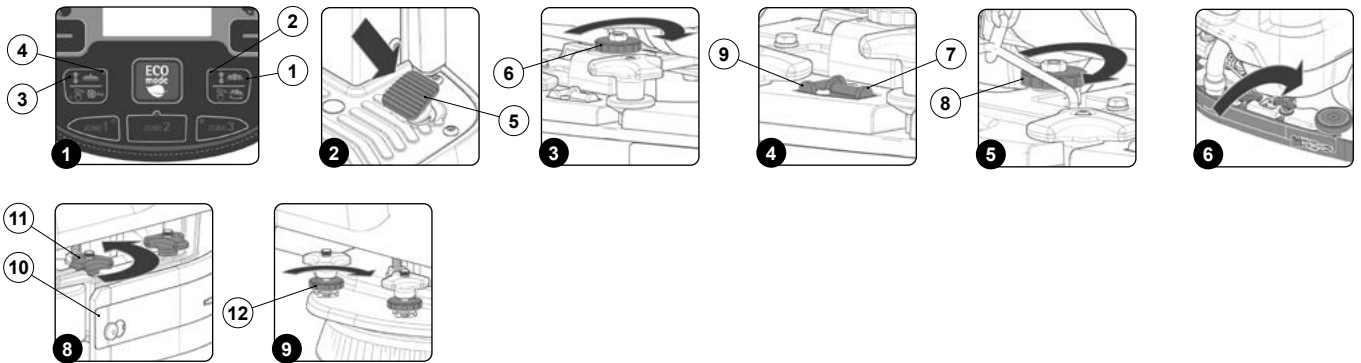

ADJUSTING THE SQUEEGEE BODY'S RUBBER BLADES

The careful adjustment of the squeegee body rubber blades guarantees better cleaning of the floor. To adjust the squeegee body blades, proceed as follows:

1. Lower the brush head body, press the "BRUSH HEAD CONTROL" button (1) on the control panel (**Fig.1**).

 **N.B.:** as soon as the button (1) on the control panel is pressed, the green LED (2) ("BRUSH HEAD BODY WORK POSITION") will switch on (**Fig.1**).

2. Lower the squeegee body and press the "SQUEEGEE CONTROL" button (3) on the control panel (**Fig.1**).

 **N.B.:** as soon as the button (3) on the control panel is pressed, the green LED (4) ("SQUEEGEE BODY WORK POSITION") will switch on (**Fig.1**).

3. Press the drive pedal (5) (**Fig.2**) to begin moving the machine.
4. As soon as the brush head and the squeegee have reached their working positions, perform the procedure for securing the machine (see the section titled "[SECURING THE MACHINE](#)").
5. Stand at the back of the machine.

Adjusting the height of the squeegee body:

- Adjust the height of the rubber blade in relation to the floor by loosening or tightening the knobs (6) (**Fig.3**).

 **N.B.:** Figure 3 indicates the direction of rotation for decreasing the distance between the squeegee support and the floor. This distance can be increased by turning it in the opposite direction.

 **N.B.:** By decreasing the distance between the squeegee support and the floor, the rubber blades present in the squeegee's body move closer to the floor.

 **N.B.:** the right-hand and left-hand knobs must be rotated the same number of times, so that the squeegee is parallel to the floor when it is working.

 **N.B.:** Check for proper adjustment by looking at the instrument (7) positioned on the squeegee body (**Fig.4**).

Adjusting the tilt of the squeegee body:

- To adjust the inclination of the squeegee body rubber blades with respect to the floor, tighten or loosen the knob (8) (**Fig.5**), until the squeegee body rubber blades are bent towards the outside evenly along the entire length by about 30° with respect to the floor.

 **N.B.:** Figure 5 indicates the direction of rotation for tilting the squeegee towards the rear of the machine (**Fig.6**). Turn it in the opposite direction to rotate the squeegee towards the front of the machine.

 **N.B.:** Check for proper adjustment by looking at the instrument (9) positioned on the squeegee body (**Fig.4**).

ADJUSTING BRUSH HEAD BODY SIDE SPLASH GUARDS

If the side splash guards of the brush head body are not positioned correctly they cannot do their work properly, namely convey the dirty detergent solution towards the squeegee, therefore the height of the splash guard needs to be adjusted. This operation can be done with the brush head body in the work position, proceeding as follows:

1. Lower the brush head body, press the "BRUSH HEAD CONTROL" button (1) on the control panel (**Fig.1**).
 - i** **N.B.:** as soon as the button (1) on the control panel is pressed, the green LED (2) ("BRUSH HEAD BODY WORK POSITION") will switch on (**Fig.1**).
2. Lower the squeegee body and press the "SQUEEGEE CONTROL" button (3) on the control panel (**Fig.1**).
 - i** **N.B.:** as soon as the button (3) on the control panel is pressed, the green LED (4) ("SQUEEGEE BODY WORK POSITION") will switch on (**Fig.1**).
3. Press the drive pedal (5) (**Fig.2**) to begin moving the machine.
4. As soon as the brush head and the squeegee have reached their working positions, perform the procedure for securing the machine (see the section titled "[SECURING THE MACHINE](#)").
5. Go to the front left-hand side of the machine.
6. Remove the left splash guard (10), unscrew the knobs (11) on the brush head body (**Fig.8**).
7. Adjust the height of the splash guard with respect to the floor, tighten or loosen the knobs (12) until the splash guard touches the floor along its entire length (**Fig.9**).
 - i** **N.B.:** By turning the knobs (12) clockwise, the splash guard support moves towards the floor (**Fig.9**).
 - i** **N.B.:** Both the front and rear of the splashguard need to be at the same height off the floor.
8. Once the adjustment has been made, reposition the left splash guard (10) and tighten the knobs (11).
9. Repeat the operations just carried out also for the right side centre as well.

CHOOSING AND USING BRUSHES

POLYPROPYLENE BRUSH (PPL)

Used on all types of floors. Good resistance to wear and tear, and hot water (no greater than 50°C.). PPL is non-hygroscopic and therefore retains its characteristics even when working in wet conditions.

ABRASIVE BRUSH

The bristles of this type of brush are charged with highly aggressive abrasives. It is used to clean very dirty floors. To avoid floor damage, work only with the pressure strictly necessary.

BRISTLE THICKNESS

Thicker bristles are more rigid and are therefore used on smooth floors or floors with small joints.

On uneven floors or those with deep joints, it is advisable to use softer bristles which can enter the gaps more easily.

Remember that when the bristles are worn and therefore too short, they will become rigid and are no longer able to penetrate and clean deep down. In this case, like with over-large bristles, the brush tends to jump.

PAD HOLDER

The pad holder is recommended for cleaning shiny surfaces.

There are two types of pad holder:

- The traditional pad holder is fitted with a series of anchor points that allow the abrasive floor pad to be held and dragged while working.
- the CENTRE LOCK type pad holder not only has anchor points, but also a snap-type central locking system in plastic that allows the abrasive floor pad to be perfectly centred and held without any risk of it becoming detached. This type of pad holder is recommended above all for machines with more than one brush, where the centring of the abrasive discs is difficult.

RED PAD

Suitable for frequent use on relatively clean floors. Even cleans without water, and polishes by removing marks.

GREEN PAD

Suitable for removing surface layers of wax and for preparing the flooring for subsequent treatments. For wet use.

BLACK PAD

Suitable for wet scraping heavy layers of wax. Removes the old finish, and eliminates burrs in concrete.

WHITE PAD

Suitable for finishing treated floors and for shiny polishing. Use dry or slightly damp.

BROWN PAD

Suitable for wet or dry scraping with wax removers. Prepare the floor for new waxing. Resistant to acids.

MACHINE	CODE	QTY	TYPE OF BRISTLE	NOTES
BMg 56 B Pro	436232	1	PPL Ø0,3	BRUSH Ø560mm Ø22in (LIGHT BLUE)
	436233	1	PPL Ø0,6	BRUSH Ø560mm Ø22in (WHITE)
	436234	1	PPL Ø0,9	BRUSH Ø560mm Ø22in (BLACK)
	436235	1	ABRASIVE	BRUSH Ø560mm Ø22in
	436236	1	-	PAD HOLDER Ø535mm Ø21in
BMg 65 B Pro	422189	2	PPL Ø0,3	BRUSH Ø340mm Ø13.4in (LIGHT BLUE)
	422971	2	PPL Ø0,6	BRUSH Ø340mm Ø13.4in (WHITE)
	422972	2	PPL Ø0,9	BRUSH Ø340mm Ø13.4in (BLACK)
	422981	2	ABRASIVE	BRUSH Ø340mm Ø13.4in
	422973	2	-	PAD HOLDER Ø320mm Ø12.6in
BMg Orbital Pro	442005	1		PAD 508x355mm 20x14in (RED)
	442661	1		PAD 508x355mm 20x14in (GREEN)
	442662	1		PAD 508x355mm 20x14in (BLACK)
	443711	1		PAD 508x355mm 20x14in (WHITE)
	443712	1		PAD 508x355mm 20x14in (BROWN)

TROUBLESHOOTING

This chapter lists the most common problems linked with the use of the machine. If you are unable to resolve the problems with the information given here, please contact your nearest assistance centre.

PROBLEM	POSSIBLE CAUSE	SOLUTION
THE MACHINE DOES NOT START	The main switch is set to "0".	Make sure that the main switch is at "I", if not turn the key to the left.
	Check that when switched on there are no alarm messages on the command display.	Stop the machine immediately, and contact a specialised service centre.
	Make sure that the batteries are correctly connected to each other and that the battery connector is connected to the electrical system connector.	Contact a Fimap assistance centre or qualified technician.
	Check the charge level of the batteries.	If the battery charge level is critical, perform a complete recharge cycle (see paragraph CHARGING THE BATTERIES ”).
THE BATTERIES ARE NOT CHARGED CORRECTLY (VERSIONS WITHOUT AN ON BOARD BATTERY CHARGER)	The connector of the battery charger cable is not properly inserted in the battery connector.	Connect the battery charger cable connector to the battery connector again.
	The plug on the battery charger's power cable is not correctly inserted into the electrical outlet.	Check that the battery charger power supply cable plug is connected to the mains socket.
	The characteristics of the mains power supply do not correspond to those required by the battery charger.	Check that the characteristics in the battery charger plate are the same as those of the mains supply.
	The LEDs of the battery charger blink repeatedly.	Referring to the battery charger use and maintenance manual, check the meaning of the flashing signals that the battery charger emits during the battery recharge stage.
THE BATTERIES ARE NOT CHARGED CORRECTLY (VERSIONS WITH AN ON BOARD BATTERY CHARGER)	The plug on the battery charger's cable is not correctly inserted into the socket on the battery charger itself.	Reconnect the battery charger's power cable.
	The plug on the battery charger's power cable is not correctly inserted into the electrical outlet.	Check that the battery charger power supply cable plug is connected to the mains socket.
	The characteristics of the mains power supply do not correspond to those required by the battery charger.	Check that the characteristics in the battery charger plate are the same as those of the mains supply.
	The LEDs of the battery charger blink repeatedly.	Referring to the battery charger use and maintenance manual, check the meaning of the flashing signals that the battery charger emits during the battery recharge stage.
THE MACHINE HAS A VERY LOW WORK AUTONOMY	Check the battery charge level, check the symbol on the command display.	If the battery charge level is critical, perform a complete recharge cycle (see paragraph CHARGING THE BATTERIES ”).

PROBLEM	POSSIBLE CAUSE	SOLUTION
INSUFFICIENT DETERGENT SOLUTION ON THE BRUSHES	The quantity of detergent solution in the water system is not sufficient for the work to be carried out.	Check that the amount of detergent solution present in the machine's water system is sufficient for the work to be carried out.
	Detergent solution filter obstructed.	Check the detergent solution filter isn't obstructed. If it is, clean it (see " CLEANING THE WATER SYSTEM FILTER ").
THE MACHINE DOES NOT CLEAN CORRECTLY	Not enough detergent solution comes out.	Read the section "INSUFFICIENT DETERGENT SOLUTION ON THE BRUSHES".
	The brushes have not been inserted correctly in the machine.	Check that the disc brushes are correctly inserted into the machine (read the section " ASSEMBLING THE BRUSH HEAD BRUSH (SINGLE BRUSH VERSION) " or read the section " ASSEMBLING THE BRUSH HEAD BRUSH (DUAL BRUSH VERSION) " or read the section " ASSEMBLING THE ABRASIVE PAD (ORBITAL VERSION) ").
	The brush bristles are excessively worn.	Check the state of wear of the brush and, if necessary, replace it.
THE SQUEEGEE DOES NOT DRY PERFECTLY	The vacuum unit is obstructed.	Make sure the squeegee is free of obstructions (read " CLEANING THE SQUEEGEE BODY ").
		Make sure the vacuum tube is free of obstructions (see " CLEANING THE VACUUM TUBE ").
		Check that the filters in the recovery tank are not clogged (see paragraph " CLEANING THE RECOVERY TANK FILTERS ").
	The cap on the recovery tank drainage tube is not properly positioned.	Check that the cap on the recovery tank drainage tube is positioned properly.
	The recovery tank lid is not positioned correctly.	Check that the recovery tank lid is properly positioned on the machine.
EXCESSIVE FOAM PRODUCTION	The detergent being used is not suitable.	Check that a low foam detergent has been used. If necessary, add a small quantity of anti-foam liquid to the recovery tank.
	The floor is not very dirty.	Dilute the detergent more.
THE MACHINE DOES NOT VACUUM CORRECTLY	The recovery tank is full.	Empty the recovery tank (read " EMPTYING THE RECOVERY TANK ").
	The vacuum device is obstructed	Read the section "THE SQUEEGEE DOES NOT DRY PERFECTLY".

EC DECLARATION OF CONFORMITY



The undersigned manufacturer:
FIMAP S.p.A.
Via Invalidi del Lavoro, 1
37059 Santa Maria di Zevio (VR)
declares under its sole responsibility that the products

SCRUBBING MACHINES - mod.
BMg 56 B Pro CB - BMg 65 B Pro CB - BMg 50 Orbital Pro CB

comply with the requirements of the following Directives:

- 2006/42/EC: Machinery Directive.
- 2014/35/EC: Low Voltage Directive.
- 2014/30/EC: Electromagnetic compatibility directive.

They also comply with the following standards:

- EN 60335-1:2012/A11:2014
- EN 60335-2-72:2012
- EN 12100:2010
- EN 60335-2-29:2004/A2:2010
- EN 61000-6-2:2005/AC:2005
- EN 61000-6-3:2007/A1:2011/AC:2012
- EN 61000-3-2:2014
- EN 61000-3-3:2013
- EN 55014-1:2006/A1:2009/A2:2011
- EN 55014-2:2015
- EN 62233:2008/AC:2008

The person authorized to compile the technical file:

Mr. Giancarlo Ruffo
Via Invalidi del Lavoro, 1
37059 Santa Maria di Zevio (VR) - ITALY

Santa Maria di Zevio (VR), 10/09/2018

Fimap S.p.A.
Legal representative
Giancarlo Ruffo

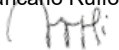

EC DECLARATION OF CONFORMITY



The undersigned manufacturer:
FIMAP S.p.A.
Via Invalidi del Lavoro, 1
37059 Santa Maria di Zevio (VR)
declares under its sole responsibility that the products

SCRUBBING MACHINES - mod.
BMg 56 B Pro - BMg 65 B Pro - BMg 50 Orbital Pro

comply with the requirements of the following Directives:

- 2006/42/EC: Machinery Directive.
- 2014/30/EC: Electromagnetic compatibility directive.

They also comply with the following standards:

- EN 60335-1:2012/A11:2014
- EN 60335-2-72:2012
- EN 12100:2010
- EN 61000-6-2:2005/AC:2005
- EN 61000-6-3:2007/A1:2011/AC:2012
- EN 62233:2008/AC:2008

The person authorized to compile the technical file:

Mr. Giancarlo Ruffo
Via Invalidi del Lavoro, 1
37059 Santa Maria di Zevio (VR) - ITALY

Santa Maria di Zevio (VR), 10/09/2018

Fimap S.p.A.
Legal representative
Giancarlo Ruffo

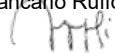



FIMAP S.p.A. - Via Invalidi del Lavoro, 1 - 37059 S. Maria di Zevio - Verona - Italy
Tel. +39 045 6060411 – Fax +39 045 6060417 – E-mail: fimap@fimap.com
www.fimap.com