

MaXima



MADE TO LAST

 **FIMAP**[®]

MaXima



A sturdy construction made with the best components and shaped in a striking design

Every detail is meant to improve ergonomics, simplicity and comfort during use. The outline protects the machine and keeps reliability high over time. At its core, innovation and technology

provide the best performance and power, ensuring high cleaning quality and efficiency. A new instrument panel makes you feel all the technology inside, totally changing the user experience.

MaXima



Maxima



MaXima

REDUCE THE TOTAL COST OF OWNERSHIP

The outer body surrounds the machine internal structure and mechanical parts, protecting them from accidental impact

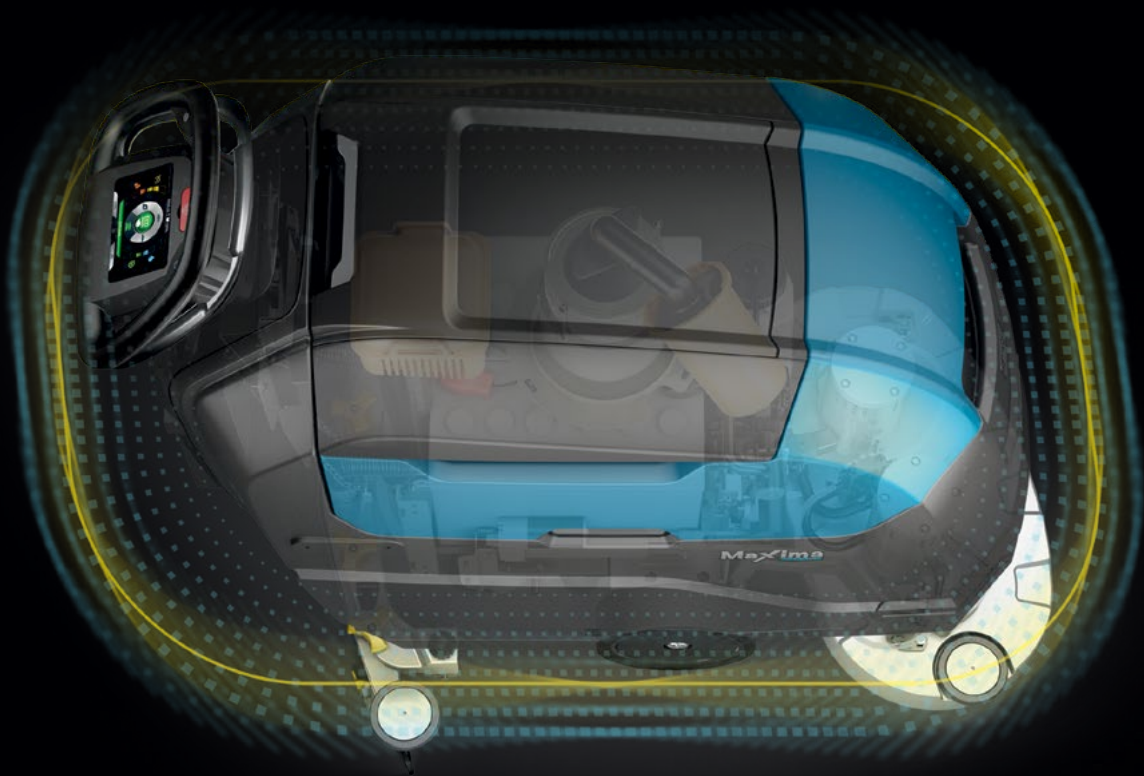

Polyethylene makes the machine sturdy and shockproof

The sturdy design reduces breakdowns,
extends the machine lifetime and helps you save time and money

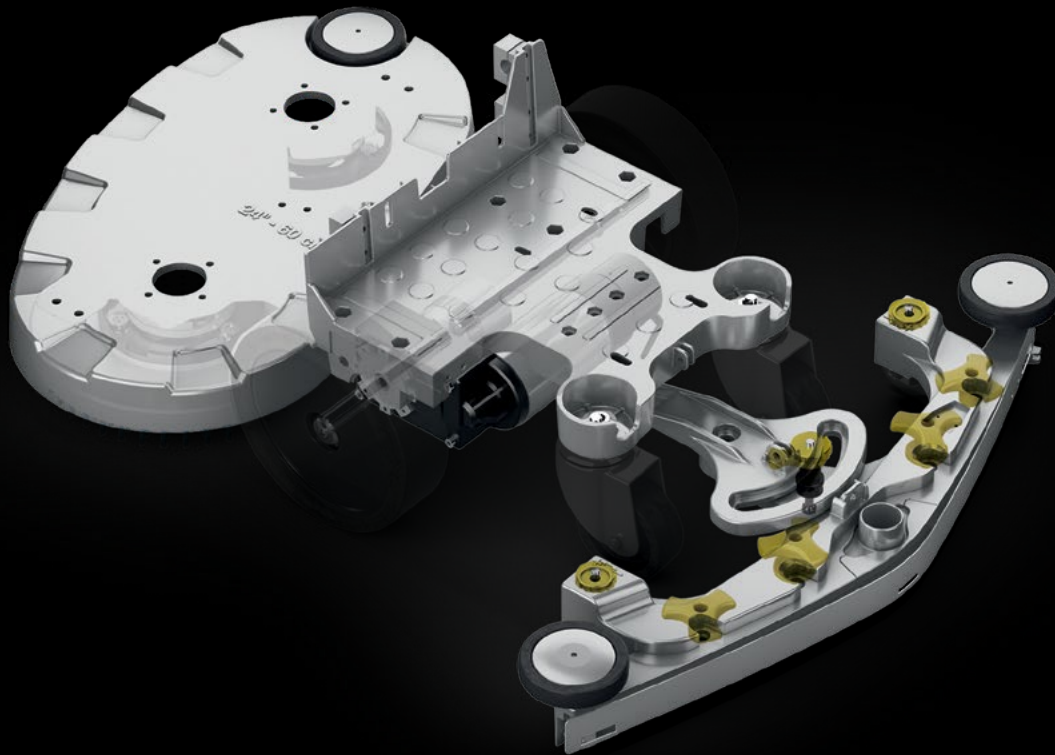

Aluminum increases machine reliability

Maxima

SAVE TIME AND REDUCE COST TO CLEAN



QUIET OPERATION IN OPENING HOURS
The Eco Mode and FNC technologies lower the noise level, safeguarding the health of the operator and of the people nearby

EASY MAINTENANCE - COLOR CODED PARTS 

Parts which must be cleaned regularly at the end of every shift are colour coded in yellow for easy identification, saving time and making sure that your scrubbing machine is kept in perfect condition at all times



FFF – FIMAP FAST FILL
Automatic system for filling the fresh water tank, lets the operator perform other activities while the tank quickly fills up



ACCESSORY STORAGE COMPARTMENT

The operator can work in absolute tranquility in the knowledge that when he needs them, all the accessories are close at hand, and once finished with, these can easily be placed back in their compartment, allowing the cleaning operation to proceed without long interruptions and wasted time.



Comfort and ease of use speed up cleaning operations



NO TRAINING

On-board machine instructions and intuitive instrument panel ensure easy and safe operation, without training

EASY MAINTENANCE

Spray gun for quick and easy cleaning of the recovery tank

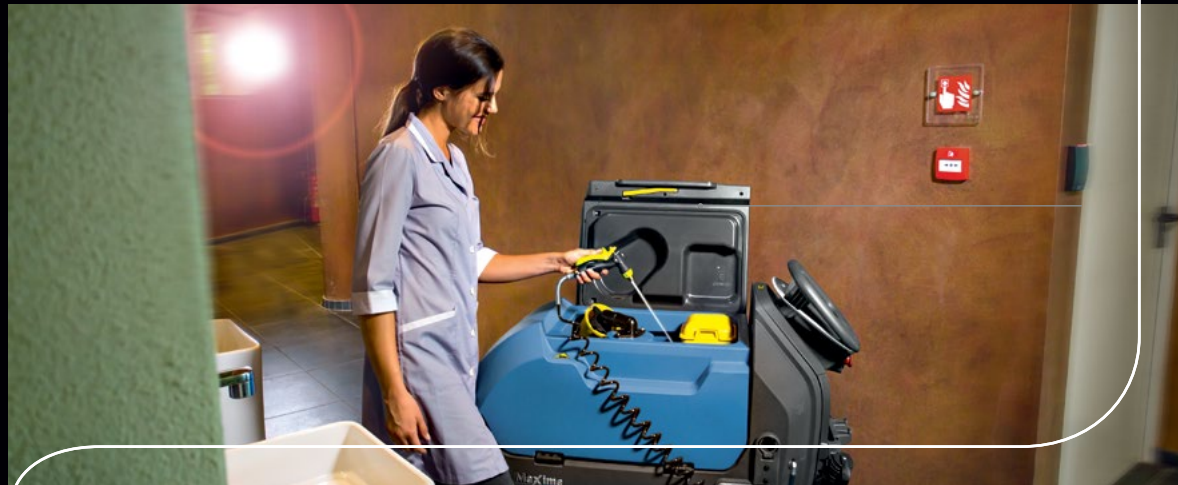

MaXima

IMPROVE YOUR FACILITY IMAGE



POWER MODE

Perfect cleaning is guaranteed in one pass

When more scrubbing power is needed, activating Power Mode increases the delivery rate of detergent solution and boosts brush pressure and vacuum power for the time necessary to tackle heavy duty cleaning



Further solutions to increase productivity



Consistent cleaning results

Pressure on the brushes is kept constant, delivering consistent high cleaning results on any type of flooring



No risk of slipping

The powerful 3-stage vacuum motor leaves the floor immediately dry and safe



Reduce downtimes

The largest tanks in its class: less stops to fill/empty the tanks



FLR-FIMAP LONG RANGE

Increases productivity by up to 70%

Great autonomy

Work for up to 4 hours non-stop



VACUUM WAND

Vacuum wand allows to clean areas that are out of reach of the machine and successfully fulfill the task



SAFETY SYSTEMS FOR ACCIDENT-FREE CLEANING

ACTIVE TECHNOLOGIES to prevent accidents



Enhances visibility in dim light

TOUCH SCREEN
DISPLAY



Control device letting the operator
set the required speed

CRUISE
CONTROL



Is automatically operated
when the machine stops.
It works as a safety parking brake

ELECTROBRAKE



For a fast operator training and reduced cost to clean

VIDEO
TUTORIALS



Maximize work safety in all conditions

LED HEADLIGHTS

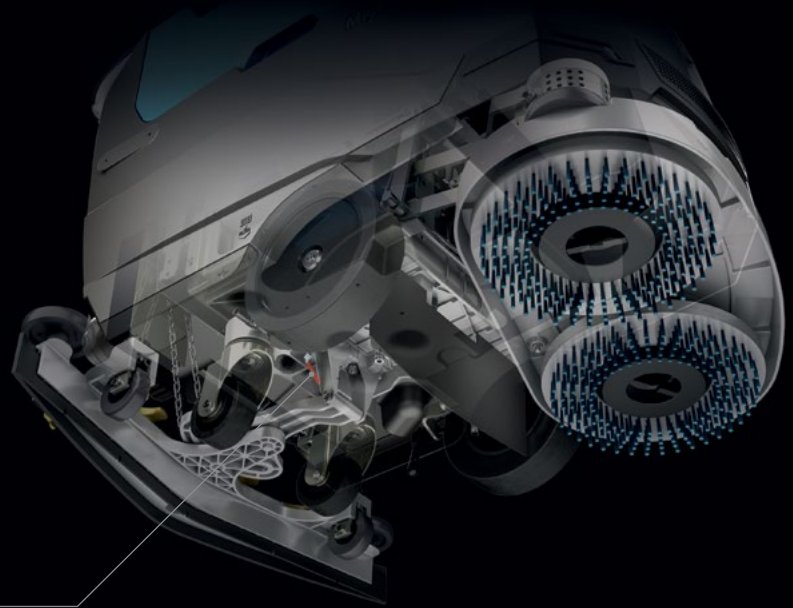

They protect the operator, the people nearby and the environment



PASSIVE SYSTEMS

to help the operator in case of emergency



SOS
DEVICE

Reduces time to service in case of emergency.
The red button sends an sms alert to receive
a prompt help, reducing downtimes



EMERGENCY
STOP

By pressing a single button the machine stops immediately

MaXima

The operator is the centre of a high-tech universe,
where everything is easy, intuitive and dynamic



iD-intelligent Drive



TOUCH SCREEN
DISPLAY



LOG-IN WITH
PASSWORD



ZONE PROGRAMS



CRUISE
CONTROL



SUSTAINABLE
CLEANING



SEVERE
CLEANING



VIDEO
TUTORIALS



All functions and activities are managed from a single interface, where a mere touch of the finger offers access to an extraordinary choice of customisable features to satisfy all types of requirements with extreme simplicity.

The high definition colour display offers the same intuitive experience as a smartphone



LOG-IN WITH PASSWORD
To protect your investment



ZONE PROGRAMS
For all the performance you'll ever need



ECO MODE
To protect the environment



POWER MODE
For maximum power when you need it

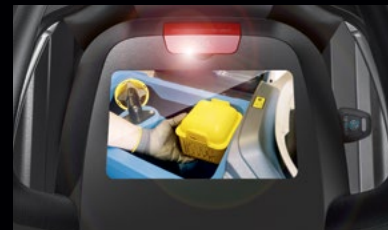

VIDEO TUTORIALS
For a more efficient, fast and easy operator training

Discover the FFM universe and experience the advantages of being constantly connected, with My.Machine app!



My.Machine

1250m²

50%

1.5h



Keep tabs on your machines remotely when you want and from wherever you want!

My.Machine app updates you in real time providing all the essential information to help you keep high the fleet performance. You can see from your smartphone or tablet where your machines are, if they're carrying out the cleaning task or

if any anomaly occurred. You can see the list of the services performed, the charger logs and anomalies occurred, in order to have a complete overview of the health status of each machine.



Watch the video



FIMAP FLEET MANAGEMENT



GEOLOCATION

It shows on a map the machine.



USE INFORMATION

It's possible to know in what working mode the machine is operating and for how long. Moreover, it provides information about the duration of each intervention and the sq.m cleaned.



HEALTH STATUS

Anytime is possible to monitor the health condition of both machines and batteries to have a clear view of the fleet availability and optimize its coordination.



ENVIRONMENTAL IMPACT

All the data related to the CO₂ produced per intervention are available as well as the water and detergent consumption, in order to take action and improve the performance.



ALARMS

The anomalies occurred are summarized in a list which includes a description of the type of issue, and the date and time of the event. It helps you to have an overview of the improper uses that need to be corrected.



BATTERY RECHARGE

It sums up all the complete and opportune recharges performed, the residual charge and the charge settings. This is an essential set of information to extend the battery lifespan and reduce the related costs.



SERVICES

An overview of the list of the maintenance services performed allows to identify discrepancies with the health condition of the machine in case an anomaly is detected, and to monitor the inspections of the whole fleet.

Maxima

SAVE RESOURCES

Advanced technological solutions offer a reduction in cost per sq.m. cleaned, more working autonomy, time savings and better cleaning results, letting you cover more surface area with the same resources.



The Eco Mode function helps prevent water, detergent and energy consumption by using only the quantities you need and nothing more

When the machine is idle, the brush motor, the vacuum motor*, the traction and the water flow will turn off automatically, reducing costs and emissions.

All the functions are reactivated automatically when the operator presence control is operated.

*Suction is not turned off automatically in E versions.
In basic and Pro versions suction turns off when the squeegee is lifted up



Sustainable solutions to protect the environment



WATER



FLR-FIMAP LONG RANGE

Reduces water and detergent consumption per cleaning operation by up to 66%*. This is a system which recycles detergent solution to increase autonomy: to scrub more sq.m. while using less resources



FSS-FIMAP SOLUTION SAVER

Water and detergent quantities are separately dosed, reducing consumption by up to 50%



FWF-FIMAP WATER FLOW

Ensures uniform cleaning results across the entire working width on the first pass, optimising detergent solution consumption

ENERGY



FES-FIMAP ENERGY SAVER

Reduces energy consumption by up to 35%

LED TECHNOLOGY

Up to 80% lower energy consumption than conventional headlights. The LED headlights consume much less energy than conventional headlights, offer a longer lifespan and illuminate with a brilliant white light similar to natural daylight



NOISE LEVELS



FNC-FIMAP NOISE CANCELLING

Reduces sound pressure

*Saving calculated on a triple recycling cycle

Choose your machine



DISC
with 1 disc brush
or 1 pad holder



DISC
with 2 disc brushes
or 2 pad holders



CYLINDRICAL
with 2 cylindrical brushes
and a debris hopper
for small sized solid debris



ORBITAL
with pad



LIGHT



MEDIUM



HEAVY



Maxima

Build your own machine:
create the perfect combination of tools that suits your
requirements

Choose the instrument panel



Basic



PRO

Membrane control panel



PLUS

Touch-screen display



ACCESSORIES

PPL 0,3

PPL 0,9

PPL 0,6

Abrasive

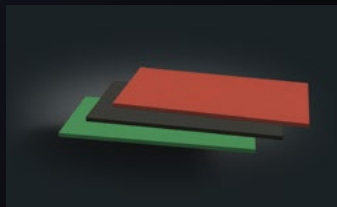
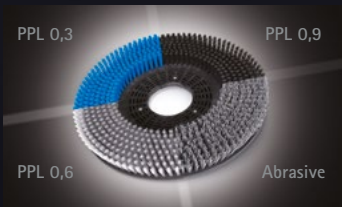

A wide choice of disc or cylindrical brushes in PPL is offered, available in thicknesses from 0.3 to 0.9 cm. These offer the perfect solution for dealing with any type of dirt on any floor.

Abrasive brushes:
Ideal for heavy duty cleaning on industrial surfaces.

Pads
BLACK – Superior abrasiveness for rapid and thorough heavy duty cleaning.
GREEN – Ideal for removing dirt from more delicate floors (rubber or linoleum).
RED – Ideal for scrubbing delicate or treated floors, and achieving an instant shine.

Rear squeegee rubber blades
33 SHORE (PARA)
For maintenance cleaning of smooth floors.
40 SHORE (PARA)
For stubborn dirt on floors with joints.
POLYURETHANE
For heavy duty cleaning on industrial floors, even with wide gaps.

OPTIONALS AND ACCESSORIES

OPTIONALS



Vacuum wand



Spray gun



FFF-FIMAP FAST FILL



FFM-FIMAP FLEET MANAGEMENT



Front driving LED headlights



FSS-FIMAP SOLUTION SAVER



Battery charger on board



Antibacterial tanks help inhibit the growth of bacteria and mold



FLR-FIMAP LONG RANGE



Supersoft Wheels



Recycled plastic tanks



AQUÆ[®]
 AQUÆ[®] + DS (Detergent dosing system)
 AQUÆ[®] + DS + Spray gun
 AQUÆ[®] + Spray gun



Squeegee holder accessory



E-Spray holder hooks

OPTIONAL AND STANDARD EQUIPMENT

USER EXPERIENCE	SINGLE DISC				DUAL DISC				CYLINDRICAL			ORBITAL		
	55 E	55 B/Bt	55 Bt Pro	55 Bt Plus	60 E	60 Bt	60 Bt Pro	60 Bt Plus	50 Bts	50 Bts Pro	50 Bts Plus	50 Bto	50 Bto Pro	50 Bto Plus
iD-Intelligent Drive:	-	-	-	•	-	-	-	•	-	-	•	-	-	•
- 5 inch high resolution colour touch screen	-	-	-	•	-	-	-	•	-	-	•	-	-	•
- Log-in with password	-	-	-	•	-	-	-	•	-	-	•	-	-	•
- Zone programs	-	-	•	•	-	-	•	•	-	•	•	-	•	•
- Cruise control	-	-	•	•	-	-	•	•	-	•	•	-	•	•
- Eco Mode	•	•	•	•	•	•	•	•	•	•	•	•	•	•
- Power Mode	-	-	-	•	-	-	-	•	-	-	•	-	-	•
- Video tutorials	-	-	-	•	-	-	-	•	-	-	•	-	-	•
Membrane control panel	-	-	•	-	-	-	•	-	-	•	-	-	•	-
COMFORT														
Hour meter	•	•	•	•	•	•	•	•	•	•	•	•	•	•
Cleaning solution level indicator	•	•	•	•	•	•	•	•	•	•	•	•	•	•
Fresh water empty tank light	-	-	-	•	-	-	-	•	-	-	•	-	-	•
Battery charger	-	○	○	○	-	○	○	○	○	○	○	○	○	○
Automatic brush coupling/uncoupling	-	-/•	•	•	-	-	-	-	-	-	-	-	-	-
Brush and squeegee actuator	-	-	-	•	-	-	-	•	-	-	•	-	-	•
Brush head actuator	-	-	•	-	-	-	•	-	-	•	-	-	•	-
Brush head manual lifting	•	•	-	-	•	•	-	-	•	-	-	•	-	-
Squeegee manual lifting	•	•	•	-	•	•	•	-	•	•	-	•	•	-
Vacuum wand with 3 stage motor	-	-	○	○	-	-	○	○	-	○	○	-	○	○
Spray gun	-	-	○	○	-	-	○	○	-	○	○	-	○	○
Accessory holder	○	○	○	○	○	○	○	○	○	○	○	○	○	○
E-Spray holder hooks	○	○	○	○	○	○	○	○	○	○	○	○	○	○
FFF (Fimap Fast Fill)	-	-	○	○	-	-	○	○	-	○	○	-	○	○
Noiseless suction	-	-	•	-	-	-	•	-	-	•	-	-	•	-
PRODUCTIVITY														
Water flow selector	-	-	•	•	-	-	•	•	-	•	•	-	•	•
Triple pressure selector	-	-	-	•	-	-	-	•	-	-	•	-	-	•
Double pressure	•	•	•	-	•	•	•	-	•	•	-	•	•	-
FFM (Fimap Fleet Management) with SOS device	-	○	○	○	-	○	○	○	○	○	○	○	○	○
Frame, squeegee and squeegee support in aluminum	•	•	•	•	•	•	•	•	•	•	•	•	•	•
Vacuum speed selector	-	-	-	•	-	-	-	•	-	-	•	-	-	•
SAFETY														
Driving LED headlights (front)	-	○	○	•	-	○	○	•	○	○	•	○	○	•
Emergency Stop	•	•	•	•	•	•	•	•	•	•	•	•	•	•
Supersoft wheels	○	○	○	○	○	○	○	○	○	○	○	○	○	○
Electro parking brake	-	-/•	•	•	-	•	•	•	•	•	•	•	•	•
Antibacterial tanks	○	○	○	○	○	○	○	○	○	○	○	○	○	○
ENVIRONMENT														
AQU/Æ®	-	-	○	○	-	-	○	○	-	-	-	-	-	-
AQU/Æ® + DS (DETERGENT DOSING SYSTEM)	-	-	○	○	-	-	○	○	-	-	-	-	-	-
AQU/Æ® + SPRAY GUN	-	-	○	○	-	-	○	○	-	-	-	-	-	-
AQU/Æ® + DS + SPRAY GUN	-	-	○	○	-	-	○	○	-	-	-	-	-	-
Recycled plastic tanks	○	○	○	○	○	○	○	○	○	○	○	○	○	○
FSS (Fimap Solution Saver)	-	-	○	○	-	-	○	○	-	-	○	○	-	○
FLR (Fimap Long Range)	-	-	○	○	-	-	○	○	-	-	○	○	-	○
FNC (Fimap Noise Canceling)	•	•	-	-	•	•	-	-	•	-	-	•	-	-
FES (Fimap Energy Saver)	•	•	•	•	•	•	•	•	•	•	•	•	•	•
FWF (Fimap Water Flow)	-	-	-	-	•	•	•	•	-	-	-	-	-	-
Start&Stop	•	•	•	•	•	•	•	•	•	•	•	•	•	•

• STANDARD

○ UPON REQUEST

- NOT AVAILABLE

DIMENSIONS AND TECHNICAL DATA

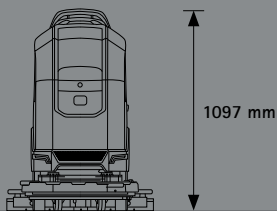

1097 mm

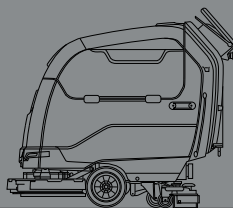

55 E/B/Bt: 1299 mm
50 Bto: 1240 mm
50 Bts: 1277 mm
60 E/Bt: 1268 mm

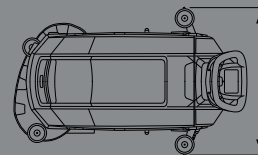

50 E/B/Bt/Bto: 712 mm
50 Bts/60 E/Bt: 785 mm

TECHNICAL DATA - Maxima	SINGLE DISC				DUAL DISC				CYLINDRICAL			ORBITAL		
	50 E	50 B/Bt	50 Bt Pro	50 Bt Plus	60 E	60 Bt	60 Bt Pro	60 Bt Plus	50 Bts	50 Bts Pro	50 Bts Plus	50 Bto	50 Bto Pro	50 Bto Plus
Productivity theoretical	up to sqm/h		-	-/2035	2035	-	2239			1776		1887		
Estimated coverage	up to sqm/h		1375			1513			1200		1275			
SCRUBBING SYSTEM														
Working width	mm	550				605				480			510	
Brush motors	(no.) V/W	(1) 230/375	(1) 24/500		(2) 230/375	(2) 24/500			(2) 24/350		(1) 24/680			
Brush rpm	rpm	140						600			-			
Oscillations	rpm	-						2000			-			
Brush pressure (min - max)	kg	21	21÷36	21÷45	27	26÷36	26÷45	25÷28	25÷35	28÷36	28÷45			
TANK AND RECOVERY SYSTEM														
Solution tank	l	60						65						
Recovery tank	l	65						121						
Suction motor	V/W	230/450	24/422		230/450	24/422			121					
Vacuum water lift	mbar	123	121		123	121			121					
3-stage vacuum motor (for vacuum wand)	V/W	-	24/680		-	24/680			-	24/680	-	24/680		
Vacuum water lift (3-stage motor)	mbar	-	181		-	181			-	181	-	181		
Detergent tank capacity (FSS)	l	-	3		-	3			-	3	-	3		
Maximum volume of the debris hopper	l	-						3,6			-	-	-	
BATTERY SYSTEM														
Supply/traction	V/Hz	230/50	24/semi aut./aut.	24/aut.	230/50	24/aut.								
Batteries	(no.) V/Ah C5	-	(2) 12/105 GEL (2) 12/110 WET		-	(2) 12/105 GEL (2) 12/110 WET								
Battery run time*	up to h	-	4,6/3,9	3,2	-	3,4	3,2	2,8	2,2	3	3,2			
PROPELLING SYSTEM														
Forward working speed	km/h	3,5						3,5						
Transport speed	km/h	3,5	3,5/4,9	4,9	3,5	4,9								
Traction motor	V/W	-	(1) 24/150		-	(1) 24/150								
SPECIFICATIONS														
Machine dimensions (L x h x w)	mm	1299 1097 558				1268 1097 641				1277 1097 567			1240 1097 547	
Squeegee width	mm	712				785				712				
Machine weight empty without batteries	kg	100	105/112	105	110	122	129	122	129	119	122			
Machine weight empty with batteries	kg	-	183/190	183	-	200	207	200	207	197	200			
GVW (Gross Vehicle Weight)	kg	154	239/246	247	164	256	271	260	275	253	264			
Sound level (ISO 11201)	dB (A)	66,8												
Sound level (ISO 11201) - Eco Mode	dB (A)	60,2												

* Run times are based on continuous scrubbing run times

SERVICES

CONSULTING AND PLANNING



We put our experience at your service, to help you realize the cleaning project perfect you. We suggest you the best solutions to make costs decrease and service quality increase.

SETUP



We can help you set up your machines in order to make them meet specifically the requirements of the sites of your project, allowing you to always have control over costs and results.

AUTHORIZED WORKSHOP NETWORK



Fimap Authorized Workshop network spans the globe, so you can enjoy the peace of mind of finding a professional support wherever your business is.

CONFIGURATION



Your business is unique, only a customized fleet can lead you to better results. We will help you find the configurations that best fit the specific requirements of your cleaning sites, in order to optimize processes and lower costs.

TRAINING COURSES



Fimap Academy offers courses for all levels, from the correct use of machines and technologies, up to the management of sites and tenders, helping you to make your service really competitive.

MAINTENANCE AND REPAIR



For your business to run smoothly it is essential that your machines are kept always operational. Our technicians take care of monitoring the machines health status and know how to intervene quickly and effectively when needed.

FINANCIAL SOLUTIONS



You can choose to use the fleet in different ways. We can advise you on the best financial solution for your business, so that you can get the quality of the Fimap world at the most convenient conditions for you.

DIGITAL FLEET MANAGEMENT SYSTEM



With Fimap Fleet Management everything is under your control. You can have a complete overview of the service provided and find out the improvements that can be made, basing your considerations on real data, always available via the My.Machine app or FFM website.

GENUINE SPARE PARTS



Get the most out of your machines, choose the reliability of Fimap original spare parts. They are designed together with the machines, so they perfectly fit them thus guaranteeing the highest quality of performance.

CERTIFICATIONS



AWARDS



For any additional information or for a demo please contact your usual Fimap dealer



FIMAP spa – Via Invalidi del Lavoro, 1 – 37059 S. Maria di Zevio – Verona – Italy – Tel. +39 045 6060411 – E-mail: contact@fimap.com



Fimap Spa reserves the right, at any time, to make technical and/or equipment modifications without prior notification. The images are shown as reference only and are not binding as to the actual design and/or equipment – Copyright © Fimap 2017 – COD. 302412 – AJ – 12-2023