

USE AND MAINTENANCE MANUAL

 **FIMAP**[®]



FSR B
FSR HYBRID

ED. 05-2018

EN

TRANSLATION
OF THE
ORIGINAL
INSTRUCTIONS
Doc. 10043527
Ver. AB



The descriptions contained in this document are not binding.
The company therefore reserves the right to make any modifications at any time to parts, details or accessory supply, as considered necessary for reasons of improvement or for manufacturing/commercial requirements.
The reproduction, even partial, of the text and drawings contained in this document is prohibited by law.

The company reserves the right to make any technical and/or supply modifications.
The images are shown as reference only and are not binding as to the actual design and/or equipment.

SYMBOLS USED IN THE MANUAL



Symbol of the open book with i:
Indicates the need to consult the instruction manual

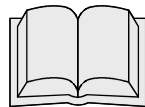

Symbol of the open book:
Used to tell the operator to read the manual before using the machine



Warning symbol
Carefully read the sections marked with this symbol and observe the indications, for the safety of the operator and the machine



Warning symbol
Indicates the risk of gas exhalation and leakage of corrosive liquids



Warning symbol
indicates the risk of fire.
Keep naked flames at a safe distance



Warning symbol
Indicates that the packed product should be handled with suitable lifting means that comply with the legal requirements



Disposal symbol
Carefully read the sections marked with this symbol for machine disposal

QUICK REFERENCE (ELECTRONIC DOCUMENT):

For quick reference of the electronic documents, use the Bookmarks and Link Pages:

Bookmarks:

Activate the "Bookmarks" panel of the interface browser, clicking the related icon (01), the icon may vary depending on the version of the Acrobat viewer.

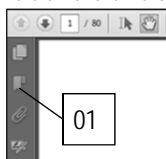

To view the required paragraph, simply click on the title in the browser (02) and you will be taken to the required destination.

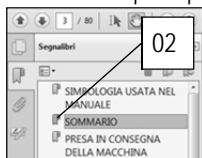

Link Page:

To view the required paragraph in the content of the document, simply click on the title of the paragraph and you will be taken to the required destination.

SOMMARIO	
PRESA IN CONSEGNA DELLA MACCHINA	5
TARGA MATRICOLA	5
PREMESSA	5

NB:

To return quickly to the contents of the document, simply click on the company logo at the top of this page, and it will send you to the required destination.

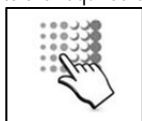



CONTENTS

ON CONSIGNMENT OF THE MACHINE	6
INTRODUCTORY COMMENT	6
IDENTIFICATION DATA	6
TECHNICAL DESCRIPTION	6
INTENDED USE	6
SERIAL NUMBER PLATE	6
TECHNICAL DESCRIPTION	7
SYMBOLS USED ON THE MACHINE	8
GENERAL SAFETY REGULATIONS	10
PREPARATION OF MACHINE	11
1. HANDLING THE PACKED MACHINE	11
2. HOW TO UNPACK THE MACHINE	11
3. HOW TO TRANSPORT THE MACHINE	11
4. HANDLEBAR CONTROL COMPONENTS	12
5. STEERING COLUMN COMPONENTS (B VERSIONS)	12
6. STEERING COLUMN COMPONENTS (HYBRID VERSIONS)	12
7. FOOTBOARD COMPONENTS	12
8. FRONT COMPONENTS	13
9. SIDE COMPONENTS	13
10. REAR COMPONENTS OF THE MACHINE	13
11. BATTERY TYPE(B VERSIONS)	13
12. BATTERY TYPE (HYBRID VERSIONS)	14
13. BATTERY MAINTENANCE AND DISPOSAL	14
14. FITTING THE BATTERIES INTO THE MACHINE(B VERSIONS)	14
15. FITTING THE BATTERIES INTO THE MACHINE (HYBRID VERSIONS)	15
16. CONNECTING BATTERIES AND BATTERY CONNECTORS (B VERSIONS)	16
17. CONNECTING THE BATTERIES AND BATTERY CONNECTOR (HYBRID VERSIONS)	17
18. BATTERY CHARGER CONNECTION (B VERSION, WITHOUT BC)	17
19. BATTERY CHARGER CONNECTION (B VERSIONS WITH BC)	18
20. CONNECTING THE BATTERY CHARGER (HYBRID VERSIONS)	20
21. CHARGE LEVEL INDICATOR OF THE BATTERIES (B VERSIONS)	21
22. HOUR METER	21
23. ADVANCEMENT AT WORK SPEED	21
24. BLINKING LIGHT (OPTIONAL)	22
25. FILLING THE FUEL TANK (HYBRID VERSIONS)	22
26. HEADLIGHTS	22
PREPARING TO WORK	23
27. PREPARING TO WORK (B VERSIONS)	23
28. PREPARING TO WORK (HYBRID VERSIONS)	24
WORK	25
29. STARTING WORK (B VERSIONS)	25
30. STARTING WORK (HYBRID VERSIONS)	27
31. EMERGENCY BUTTON	31
32. ALTERNATOR FAULT WARNING LIGHT (HYBRID VERSIONS)	31
33. EMPTYING THE DEBRIS HOPPER	32
AT THE END OF THE WORK	34
DAILY MAINTENANCE	36
34. CLEANING THE CENTRAL BRUSH	36
35. CLEANING THE SIDE BRUSH	37
WEEKLY MAINTENANCE	38
36. CLEANING THE PANEL FILTER	38
37. CLEANING THE FABRIC FILTER (OPTIONAL)	39
38. CLEANING THE DEBRIS HOPPER	40
EMERGENCY MAINTENANCE	41



39. SIDE BRUSH ADJUSTMENT	41
40. CENTRAL BRUSH FLAP ADJUSTMENT	41
41. CENTRAL BRUSH REPLACEMENT	42
42. REPLACING THE SIDE BRUSH.....	43
MAINTENANCE OF THE COMBUSTION ENGINE	44
TROUBLESHOOTING.....	45
43. THE MACHINE DOES NOT START.....	45
44. THE COMBUSTION ENGINE DOES NOT START	45
45. THE MACHINE DOES NOT CLEAN WELL	45
46. THE MACHINE RAISES DUST WHEN OPERATING	45
47. EXCESSIVE OR ALTERED NOISE OF THE CENTRAL BRUSH.....	45
48. EXCESSIVE OR ALTERED NOISE OF THE SIDE BRUSH	45
DISPOSAL	46
CHOOSING AND USING THE BRUSHES.....	47
NOTES	47
EC DECLARATION OF CONFORMITY	48



ON CONSIGNMENT OF THE MACHINE

When the machine is consigned to the customer, an immediate check must be performed to ensure all the material mentioned in the shipping documents has been received, and also to check the machine has not suffered damage during transportation. If this is the case, the carrier must ascertain the extent of the damage at once, informing our customer service office. It is only by prompt action of this type that the missing material can be obtained, and compensation for damage successfully claimed.

INTRODUCTORY COMMENT

Even the best machines will only work well if used correctly and kept in good working order. We therefore suggest you read this instruction booklet carefully and read it again whenever difficulties arise while using the machine. If necessary, remember that our assistance service (organised in collaboration with our dealers) is always available for advice or direct intervention.

IDENTIFICATION DATA

For technical assistance or to request replacement parts, always give the model, the version and the serial number (written on the relevant plate).

TECHNICAL DESCRIPTION

The FSR B is a sweeping machine with an on-board operator, powered by batteries, designed to clean indoor surfaces with tiled, concrete and asphalt flooring.

The FSR Hybrid is a sweeping machine with an on-board operator, powered by an endothermic motor or a battery, designed to clean indoor and outdoor surfaces with tiled, concrete and asphalt flooring.

The machine must operate on dry surfaces, and if necessary can also work on wet surfaces making sure the vacuum action is not active. The machine features a central brush for the collection of brushed up material, a side brush for cleaning edges and corners, a vacuum system with filter to avoid raising dust, and a debris hopper that can be manually removed by means of a mechanical leverage.

INTENDED USE

The FSR B is designed to clean indoor surfaces with tiled, concrete and asphalt floors, for exclusively professional use in industrial, commercial and public places.

The FSR Hybrid is designed to clean both inside and outside surfaces with tiled, concrete and asphalt floors, for professional use in industrial, commercial and public places.

The FSR B is only suitable for use in closed, or at least covered, places.

The FSR B and FSR Hybrid machines are not suitable for use in rain or under jets of water.

It is forbidden to use the FSR B and FSR Hybrid machines for picking up dangerous powders or inflammable liquids in places with an explosive atmosphere. In addition, it is not suitable as a means of transport for people or objects.

SERIAL NUMBER PLATE

The serial number plate is located at the rear of the steering column, and indicates the general characteristics of the machine, in particular the serial number of the machine. The serial number is an extremely important piece of information and should always be provided together with any request for assistance or to purchase spare parts.

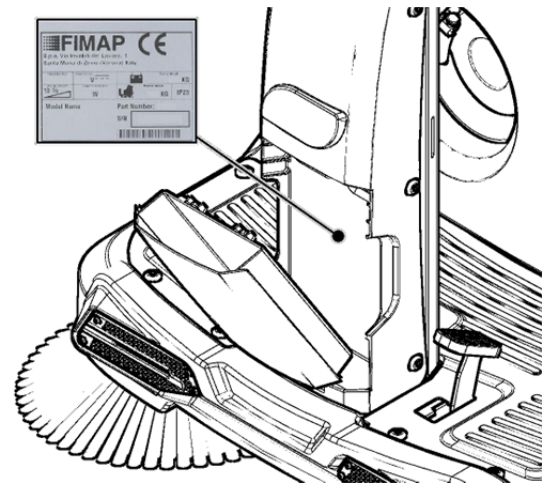



TECHNICAL DESCRIPTION	U/M	FSR B	FSR HYBRID
Working width without side brush	mm	580	580
Working width with right side brush	mm	790	790
Working width with left and right side brush	mm	1000	1000
Working capacity, up to (2SL version with two side brushes)	m ² /h	5100	4600
Central brush	∅ mm	260	260
Side brush	∅ mm	400	400
Central brush rpm	rpm	550	550
Side brush rpm	rpm	65	65
Endothermic engine	HP / rpm	-	4.8 / 3600
Central brush motor	V/W	24/380	24/380
Side brush motor	V/W	24/90	24/90
Traction motor	V/W	24/300	24/300
Vacuum motor	V/W	24/400	24/400
Filter shaker motor	V/W	24/80	24/80
Total power	W	1250	1250
Front wheel ((number / (diameter x width))	No. / (∅ mm x mm)	1 / (175x60)	1 / (175x60)
Rear wheel ((number / (diameter x width))	No. / (∅ mm x mm)	1 / (225x69)	1 / (230x88)
Working forward speed	km/h	4.8	4.8
Maximum gradient	%	10	10
Filter surface area (optional fabric filter)	sq.m.	2.2	2.2
Filter surface area (paper filter)	sq.m.	3.2	3.2
Debris hopper volume	dm ³	20	20
Steering diameter	mm	1430	1430
Machine length	mm	1455	1455
Machine height	mm	1030	1030
Machine height with blinking light	mm	1080	1080
Machine width	mm	845	845
Battery compartment (l x w x h)	mm	340x174x310	-
Battery compartment (l x w x h)	mm	-	270x360x240
Rated battery voltage	V	12	12
Battery weight	kg	36.5	20
Unladen machine weight (without batteries)	kg	175	-
Unladen machine weight (Combustion engine without fuel)	kg	-	252
Machine weight during transport (machine + batteries + brushes)	kg	248	-
Machine weight during transport (machine + brushes + Combustion engine without fuel)	kg	-	255
Machine weight in running order (machine + batteries + brushes + operator)	kg	323	-
Machine weight in running order (machine + brushes + Combustion engine fuel + operator)	kg	-	325
Sound pressure level (ISO 11201) - LpA	dB (A)	60.5	81.2
Uncertainty KpA	dB (A)	1.4	1.4
Hand vibration level (ISO 5349)	m/s ²	< 2.5	< 2.5
Body vibration level (ISO 2631)	m/s ²	< 0.5	< 0.5



SYMBOLS USED ON THE MACHINE

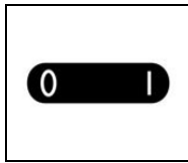

Main switch symbol (version B).
Used on the steering column to indicate the key switch for machine operation on (I) or off (0).



Main switch symbol (Hybrid version).
Used on the steering column to indicate the key switch that manages the type of power supply of the machine.



Alternator fault symbol (Hybrid version).
Used on the steering column to indicate with red warning light of a fault in the electrical system inherent to the alternator.



Horn symbol.
Used to indicate the acoustic alarm button.

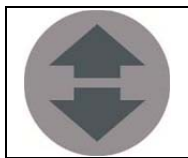

Symbol of the reverse movement selector.
Used to indicate the button for engaging the reverse gear.

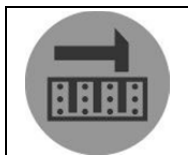

Filter shaker symbol.
Used on the instrument panel to indicate the button that starts the vibrating shaker on the filter unit.



Symbol denoting vacuum motor.
Used on the instrument panel to indicate the button that commands the deactivation of the vacuum motor.



Central brush movement symbol (idle position).
Used on the rear of the steering column to indicate the movement lever of the central brush.



Central brush movement symbol (working position).
Used on the rear of the steering column to indicate the movement lever of the central brush.



SYMBOLS USED ON THE MACHINE

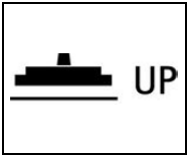

Side brush/es movement symbol (idle position).
Used on the rear of the steering column to indicate the movement lever of the side brush/es.



Side brush/es movement symbol (working position).
Used on the rear of the steering column to indicate the movement lever of the side brush/es.



Combustion engine pull start symbol.
Used to indicate the position of the handle that allows the pull start of the combustion engine.

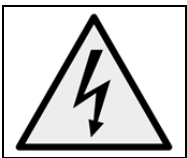

Danger of contact with live parts symbol (Hybrid version).
Used on the cover of the electrical system's control board.



Indicates the risk of crushed hands.



Indicates the risk of burns due to the hot surface.

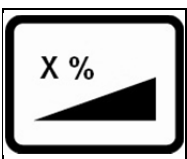

Indicates the maximum gradient.



Symbol of the open book:
Tells the operator to read the user manual before using the device.



GENERAL SAFETY REGULATIONS

The regulations below must be carefully followed in order to avoid harm to the operator and damage to the machine.

WARNING:

- Read the labels on the machine carefully. Do not cover them for any reason and replace them immediately if they become damaged.
- The machine must be used exclusively by authorised and trained personnel.
- The machine is designed for dry use only.
- Do not use the machine on surfaces with an inclination greater than the one shown on the plate.
- The machine is not suitable for cleaning rough or uneven floors. Do not use the machine on slopes.
- In the event of danger, quickly intervene on the emergency button or the handle located on the battery connector.
- Before carrying out any maintenance work, switch off the machine and disconnect the battery connector.
- Children must be supervised to ensure they do not play with the device.
- During the working of the machine, pay attention to other people and especially to children.
- Only use the brushes supplied with the machine, or those specified in the "CHOOSING AND USING THE BRUSHES" paragraph of the instruction manual. The use of other brushes could compromise safety levels.

ATTENTION:

- The machine is not suitable for use by children and persons with reduced physical, mental and sensory capabilities, or people who lack experience and knowledge.
- The machine must not be used or stored outdoors, in damp conditions or directly exposed to rain.
- The storage temperature must be between -25°C and +55°C; do not store outdoors in damp conditions.
- Conditions of use: °room temperature between 0°C and 40°C with relative humidity between 30 and 95%.
- The socket for the battery charger cable must have a prescribed earth connection.
- Adapt the speed to the adhesion conditions.
- Do not use the machine as a means of transport.
- The machine does not cause harmful vibrations.
- Do not use the machine in an explosive atmosphere.
- Do not use the device to collect dangerous powders.
- The machine is not suitable for cleaning carpets.
- Do not place any liquid containers on the machine.
- Avoid working with the brushes when the machine is standing still, so as not to damage the floor.
- In the event of a fire, use a powder extinguisher. Do not use water.
- Do not knock against shelving or scaffolding, where there is a danger of falling objects. The operator must always be equipped with the appropriate safety devices (gloves, shoes, helmet, goggles, etc.).
- If the machine does not work properly, check this is not caused by failure to carry out routine maintenance. Otherwise, ask for intervention of the authorised technical assistance centre.
- If you need to replace any components, request the ORIGINAL spare parts from an Authorised dealer and/or Retailer.
- Restore all electrical connections after any maintenance interventions.
- Before using the machine, check that all the hatches and covers are positioned as shown in this Use and Maintenance Manual.
- Do not remove any protection devices which require the use of tools in order to be removed.
- Do not wash the machine with direct water jets or with pressurised water, nor with corrosive substances.
- Have the machine checked by an authorised technical assistance centre every year.
- When disposing of consumable materials, observe the laws and regulations in force.
- When your machine has reached the end of its long working life, dispose of the materials it contains (especially oils, batteries and electronic components) in an appropriate manner, taking into account that the machine itself was constructed using 100% recyclable materials.
- The batteries must be removed from the machine before its disposal. The batteries must be disposed of in a safe manner, fully observing the laws and regulations in force.
- Keep children and animals away from the powered motor, as it heats up and may cause burns and injuries (both directly and via the machines which it moves).
- Learn how to switch the motor off quickly, and how to use all the controls. Never entrust the motor to people who haven't had the appropriate training.
- While the motor is switched on, do not place any inflammable objects (gasoline, matches, etc.) near it.
- Top up the fuel in a well-ventilated area, with the engine switched off. Gasoline is highly inflammable and may explode.
- Do not completely fill the fuel tank. Check the cap is firmly closed.
- If any fuel is spilled, clean the area thoroughly and allow the vapours to disperse before switching on the motor.
- Do not smoke or take any unprotected flames in the area where the motor is filled with fuel, or where the gasoline is stored.
- The exhaust gases contain carbon monoxide - an odourless, colourless, but highly poisonous gas. Avoid inhalation. Do not switch the motor on in a closed garage or in a room without windows.



PREPARATION OF MACHINE

1. HANDLING THE PACKED MACHINE

The machine is contained in specific packaging with a pallet for the handling with fork trucks.
The packages CANNOT be placed on top of each other.
The total weight of the machine with its packaging is 210 kg (for FSR B versions)
The total weight of the machine with its packaging is 290 kg (for FSR HYBRID versions)
The packaging dimensions are as follows:

FSR
A: 1270 mm
B: 1020 mm
C: 1760 mm

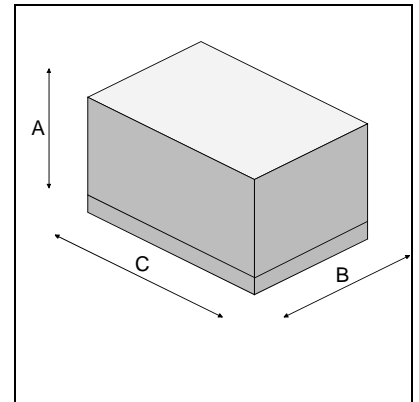

2. HOW TO UNPACK THE MACHINE

1. Remove the outer package.
2. Disengage the electronic brake, turn the lever (1) (on the rear right-hand side of the machine) clockwise.
3. The machine is fixed to the pallet with wedges which block the wheels. Remove the wedges.

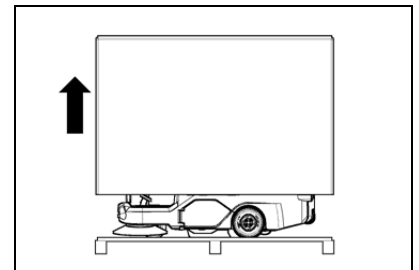

4. Use a chute to get the machine down from the pallet, pushing it backwards.



ATTENTION: During transportation, the electrical brake should not be engaged, the machine will in any event, if the critical speed threshold is crossed, activate the internal braking system of the chopper circuit board and will emit a warning noise.

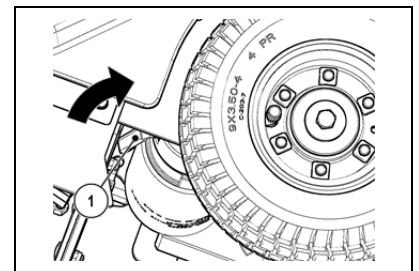

5. Keep the pallet for any future transport needs



ATTENTION: If the product is delivered in cardboard containers, handle the packed product with suitable lifting means that comply with the legal requirements



ATTENTION: During this operation, check there are no people or objects near the machine

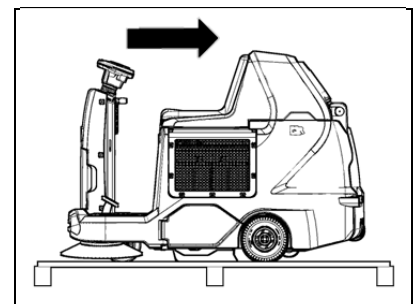

3. HOW TO TRANSPORT THE MACHINE

1. Check that the central brush is lifted from the ground, otherwise lift it by moving the lever on the rear of the steering column.
2. Check that the side brush/es is/are lifted from the ground, otherwise lift it/them by moving the lever on the rear of the steering column.
3. Place it on a pallet using a chute.
4. Check the main switch is set to "0", if this is not the case, turn the key by a quarter of a turn to the left.
5. Remove the key from the main switch.
6. Secure the machine to the pallet using wooden wedges.
7. Engage the electronic brake.

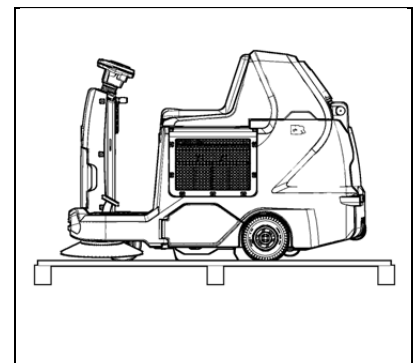



PREPARATION OF MACHINE



ATTENTION: With regard to the transport of a hybrid version machine, follow the instructions given in the user manual of the combustion engine (supplied with the machine).

4. HANDLEBAR CONTROL COMPONENTS

The handlebar control components are identified as follows:

1. Level indicator for battery/hour meter.
2. Filter shaker control button.
3. Horn button.
4. Reverse button.
5. Vacuum motor "STOP" button.

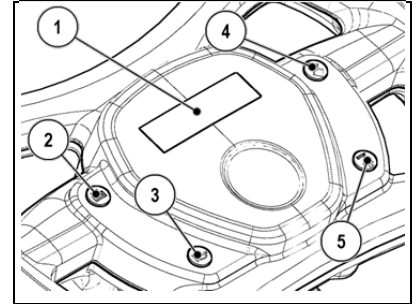

5. STEERING COLUMN COMPONENTS (B VERSIONS)

The steering column components are identified as follows:

1. Central brush lifting lever.
2. Lever for raising the side brush (1SL version) or brushes (2SL version).
3. Main key switch.
4. Emergency button.

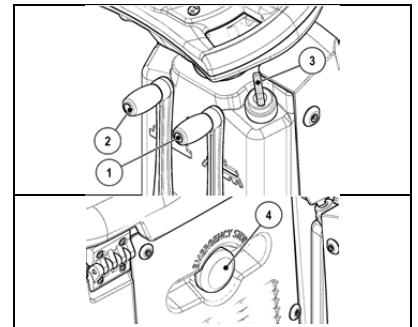

6. STEERING COLUMN COMPONENTS (HYBRID VERSIONS)

The steering column components are identified as follows:

1. Central brush lifting lever.
2. Lever for raising the side brush (1SL version) or brushes (2SL version).
3. Main key switch.
4. Emergency button.
5. Red warning light, which warns of a malfunction of the alternator to the electrical system.

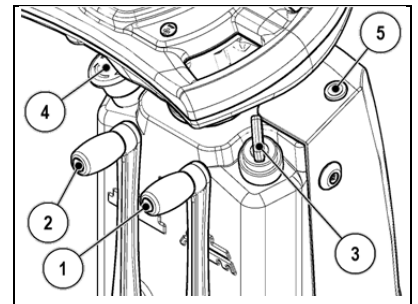

7. FOOTBOARD COMPONENTS

The footboard components are identified as follows:

1. Drive pedal, accelerator pedal.
2. Front flap lifting pedal.

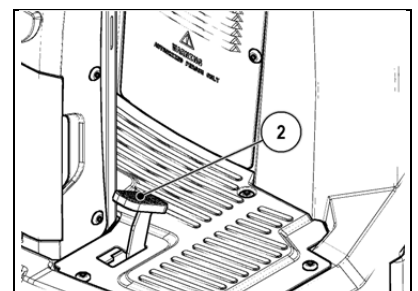
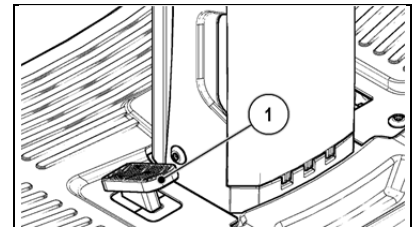



PREPARATION OF MACHINE

8. FRONT COMPONENTS

The front components of the machine are identified as follows:

1. Storage compartment.
2. Headlights.

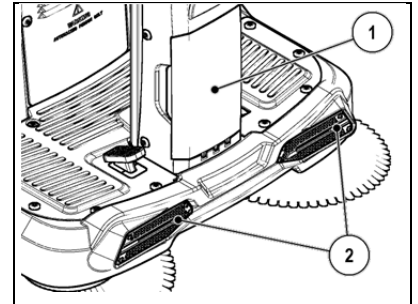

9. SIDE COMPONENTS

The components on the side of the machine are identified as follows:

1. Left side panel central brush engage/adjustment.
2. Seat unit lifting handle.

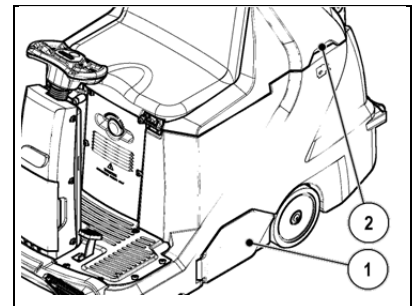

3. Right side panel central brush maintenance.
4. Seat unit lifting handle.

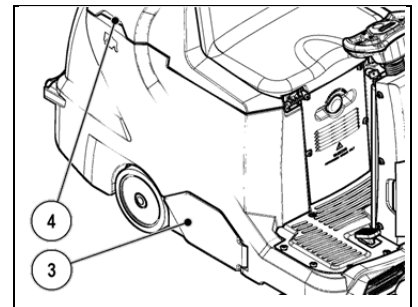

10. REAR COMPONENTS OF THE MACHINE

The rear components of the machine are identified as follows:

1. Debris hopper retainer.
2. Debris hopper handle.
3. Blinking light (optional).

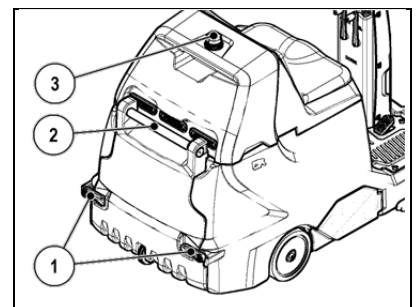

11. BATTERY TYPE(B VERSIONS)

Power to the machine must be supplied by four sealed traction batteries with gas recombination or gel technology. OTHER TYPES MUST NOT BE USED.

The batteries must meet the requirements laid out in the norms:

CEI EN 60254-1:2005-12 (CEI 21-5) + CEI EN 60254-2:2008-06 (CEI 21-7)

The battery compartment can house two 12 V batteries

For a good operating performance, we suggest the use of 105 Ah C5 batteries



PREPARATION OF MACHINE

12. BATTERY TYPE (HYBRID VERSIONS)

To power the machine, "double application" sealed batteries must be used, starter and total discharge OPTIMA BT DC 4.2 12 V 55 Ah. OTHER TYPES MUST NOT BE USED.

The batteries must meet the requirements laid out in the norms:

CEI EN 60254-1:2005-12 (CEI 21-5) + CEI EN 60254-2:2008-06 (CEI 21-7)

The battery compartment can house two 12 V - 55 Ah batteries

13. BATTERY MAINTENANCE AND DISPOSAL

For information about battery maintenance, refer to the instructions provided by the battery manufacturer. When the battery reaches the end of its working life, it must be disconnected by expert, trained personnel, then lifted (using the grips and suitable lifting devices) to remove it from the battery compartment. EXHAUSTED BATTERIES ARE CLASSIFIED AS DANGEROUS WASTE AND MUST BE CONSIGNED TO THE AUTHORISED BODIES FOR CORRECT DISPOSAL.



ATTENTION: users are advised to always wear protective gloves, to avoid the risk of serious injury to hands.



ATTENTION: you are advised to only lift and move the batteries with lifting and transportation means suitable for the specific weight and size

14. FITTING THE BATTERIES INTO THE MACHINE(B VERSIONS)

The batteries must be housed in the appropriate compartment beneath the seat unit. They should be handled using lifting equipment that is suitable in terms of both weight and coupling system. They must also satisfy the requirements of Standard CEI 21-5. The dimensions of the battery compartment are: 340 x 174 x H310 mm.



ATTENTION: for battery maintenance and daily recharging, you must fully respect the indications provided by the manufacturer or retailer. all installation and maintenance operations must be carried out by specialised personnel.



ATTENTION: make sure that you comply with the accident prevention regulations in force in the country where you work or with DIN EN 50272-3 and DIN EN 50110-1, before any handling of the batteries.

ATTENTION: to prevent an accidental short circuit use insulated tools to connect the batteries, and do not place or drop metal objects on the battery. Remove rings, watches and any clothing with metal parts that may come into contact with the battery terminals.

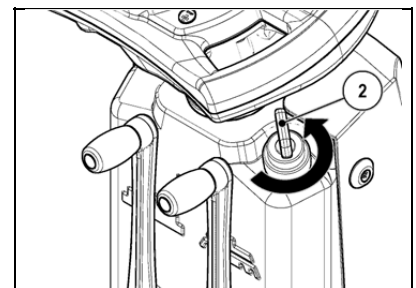
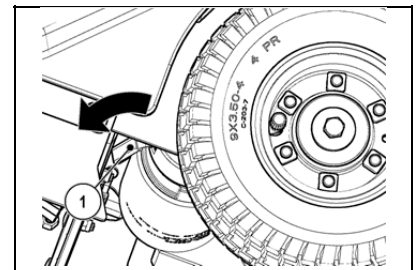

To insert the batteries into the compartment proceed as follows:

1. Make sure the electric brake is engaged, otherwise engage it using the lever (1) located at the left rear of the machine (working direction).
2. Check the main switch (2) is in the "0" position, if this is not the case, turn the key by a quarter of a turn to the left, and remove the key from the instrument panel.



PREPARATION OF MACHINE

3. Grasp the handle located on the side of the operator seat unit.
4. Lift the operator seat unit until the safety clamp (3) is hooked.

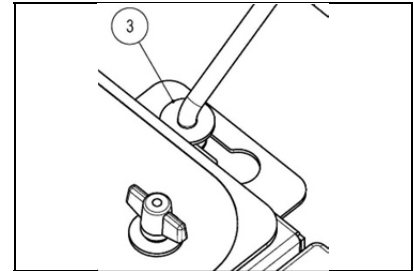

ATTENTION: Before installing the battery, clean the battery compartment with a damp cloth. Check that the connectors on the cables supplied are functioning correctly.

ATTENTION: check that the characteristics of the battery that you are looking to use are appropriate for the type of work to be performed. Check the battery charge and the condition of the contacts on the battery.



ATTENTION: You are advised to only lift and move the batteries with lifting and transportation means suitable for the specific weight and size.

ATTENTION: the lifting hooks must not damage the blocks, connectors or cables.

5. House the batteries in their compartment, positioning the "+" and "-" poles opposite each other.



ATTENTION: Before inserting the batteries into the machine, remember to cover the terminals with a little grease to protect them against external corrosion.

ATTENTION: You are advised to use airtight batteries only, to avoid the leakage of acids!

ATTENTION: users are advised to always wear protective gloves, to avoid the risk of serious injury to hands.

15. FITTING THE BATTERIES INTO THE MACHINE (HYBRID VERSIONS)

The batteries must be housed in the appropriate compartment beneath the seat unit. They should be handled using lifting equipment that is suitable in terms of both weight and coupling system. They must also satisfy the requirements of Standard CEI 21-5. The dimensions of the battery compartment are: 270 x 360 x H240 mm.



ATTENTION: for battery maintenance and daily recharging, you must fully respect the indications provided by the manufacturer or retailer. all installation and maintenance operations must be carried out by specialised personnel.



ATTENTION: make sure that you comply with the accident prevention regulations in force in the country where you work or with DIN EN 50272-3 and DIN EN 50110-1, before any handling of the batteries.

ATTENTION: to prevent an accidental short circuit use insulated tools to connect the batteries, and do not place or drop metal objects on the battery. Remove rings, watches and any clothing with metal parts that may come into contact with the battery terminals.

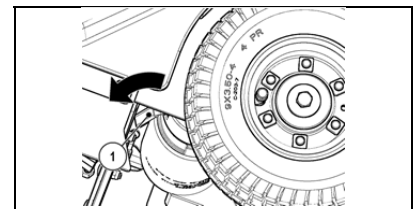

To insert the batteries into the compartment proceed as follows:

1. Make sure the electric brake is engaged, otherwise engage it using the lever (1) located at the left rear of the machine (working direction).
2. Check the main switch (2) is in the "0" position, if this is not the case, turn the key by a quarter of a turn to the left, and remove the key from the instrument panel.

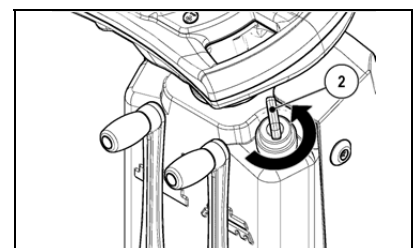



PREPARATION OF MACHINE

3. Grasp the handle located on the side of the operator seat unit.
4. Lift the operator seat unit until the safety clamp (3) is hooked.
5. Check that the motor switch is in the "0" position, if this is not the case, turn the handle by a quarter of a turn to the left, and remove the key from the instrument panel.

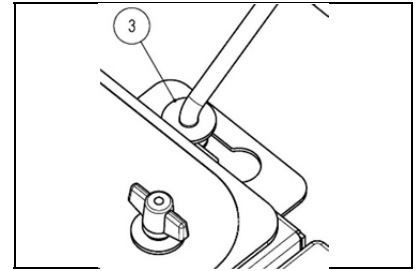

6. Using the appropriate tools, remove the screws (4) securing the grille (5) on the left side to the body.
7. Remove the grille (5) on the left side of the body.

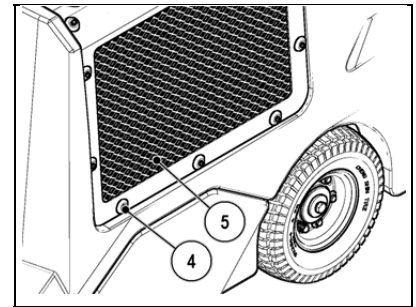

ATTENTION: Before installing the battery, clean the battery compartment with a damp cloth. Check that the connectors on the cables supplied are functioning correctly.

ATTENTION: check that the characteristics of the battery that you are looking to use are appropriate for the type of work to be performed. Check the battery charge and the condition of the contacts on the battery.

8. Using the appropriate tools, remove the screws (6) securing the plate (7) of the control board support.
9. Remove the control board unit.

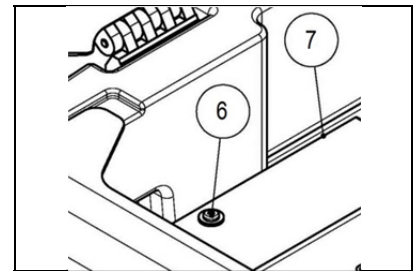

ATTENTION: You are advised to only lift and move the batteries with lifting and transportation means suitable for the specific weight and size.

ATTENTION: the lifting hooks must not damage the blocks, connectors or cables.

10. House the batteries in the compartment, positioning the "+" and "-" poles opposite each other.
11. Secure the batteries among them by means of the belt (8) supplied.

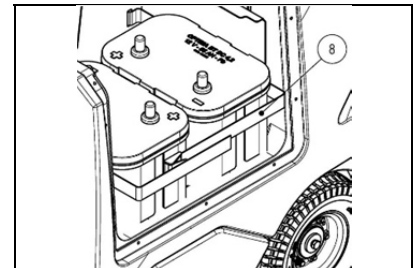

16. CONNECTING BATTERIES AND BATTERY CONNECTORS (B VERSIONS)

To connect the batteries proceed as follows:

1. Connect the batteries in series to the "+" and "-" poles using the supplied jumper cable (1).
2. Connect the battery connector cable to the "+" and "-" poles in order to obtain the terminal voltage of 24 V.
3. Connect the electric system connector (3) to the battery connector (2).

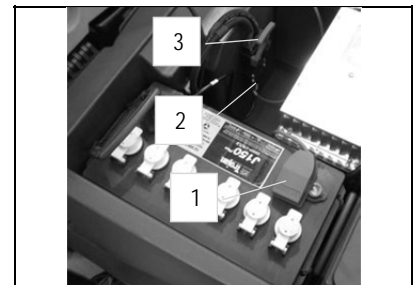

ATTENTION: All installation and maintenance operations must be carried out by expert personnel, trained at the specialised assistance centre.

ATTENTION: users are advised to always wear protective gloves, to avoid the risk of serious injury to hands.



PREPARATION OF MACHINE

17. CONNECTING THE BATTERIES AND BATTERY CONNECTOR (HYBRID VERSIONS)

To connect the batteries proceed as follows:

1. Using the appropriate tools, remove the screws (1) securing the plate (2) of the control board support.
2. Remove the control board unit.
3. Connect the batteries in series to the "+" and "-" poles using the supplied jumper cable (3).
4. Connect the batteries' connector cable (4) to the "+" and "-" poles to obtain a voltage of 24 V at the terminals.
5. Connect the electrical system connector to the battery connector.

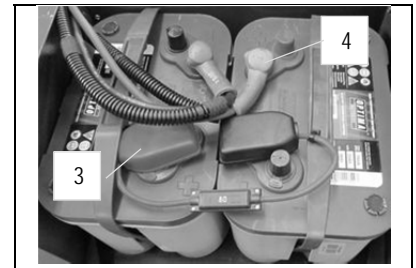
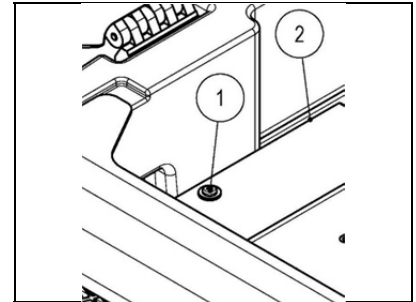

18. BATTERY CHARGER CONNECTION (B VERSION, WITHOUT BC)

In order not to cause permanent damage to the batteries, it is essential to avoid their complete discharge: arrange the recharge within a few minutes of the switching on of the "discharged batteries" blinking light.



ATTENTION: Never leave the batteries completely discharged, even if the machine is not being used. Check the battery charger is suitable for the batteries installed, in terms of both capacity and type.

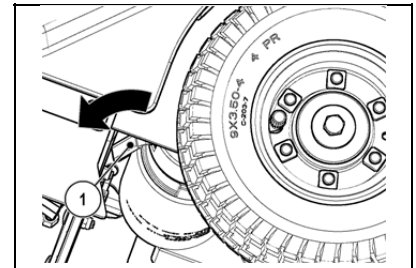

To connect the battery charger you must:

1. Move the machine to the place used for maintenance or recharging the batteries.
2. Make sure the electric brake is engaged, otherwise engage it using the lever (1) located at the left rear of the machine (working direction).
3. Check the main switch (2) is in the "0" position, if this is not the case, turn the key by a quarter of a turn to the left, and remove the key from the instrument panel.

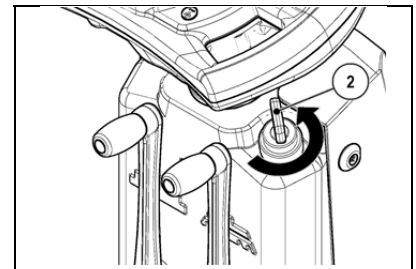

4. Grasp the handle located on the side of the operator seat unit.
5. Lift the operator seat unit until the safety clamp (3) is hooked.



ATTENTION: Park the machine in a place protected from the weather and with suitable ventilation, and on a flat and level surface; near the machine there must be no objects that could either damage it, or be damaged through contact with it.

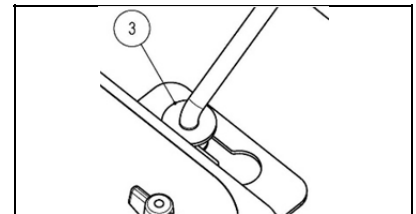

6. Disconnect the electric system connector (4) from the battery connector (5).



ATTENTION: This process must be carried out by qualified personnel. An incorrect connection of the connector may cause problems with machine functioning.

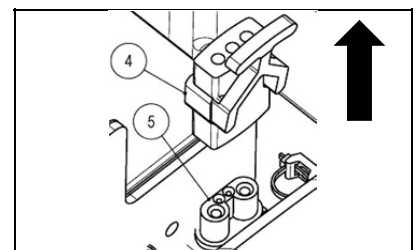



PREPARATION OF MACHINE

7. Connect the battery charger cable (6) to the battery connector (5).



ATTENTION: Keep the seat unit open for the duration of the battery recharging cycle to allow gas fumes to escape.

ATTENTION: the room used to recharge the batteries must be adequately ventilated to prevent the accumulation of gases that leak from batteries.

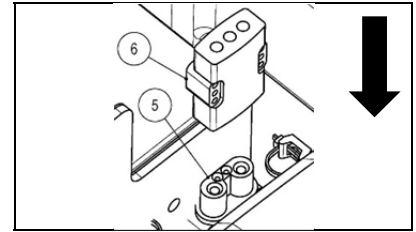

The coupling connector of the battery charger is supplied inside the bag containing this instruction booklet, and must be fitted to the battery charger cables as shown in the instructions.

8. Connect the recently wired cable to the external battery charger.



ATTENTION: carefully read the use and maintenance instructions of the battery charger that is used for charging.



ATTENTION: Danger of gas exhalation and leakage of corrosive liquids.



ATTENTION: Danger of fire: keep naked flames at a safe distance.

9. When the recharge cycle is complete, disconnect the battery charger connector from the external battery charger.
10. Disconnect the battery charger cable (6) from the battery connector (5).

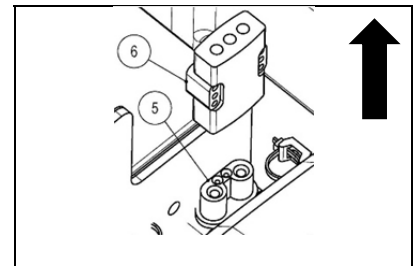

11. Connect the battery connector (5) to the electric system connector (4).
12. Grip the handle on the side of the operator seat unit and lower the seat unit until it is in the working position.

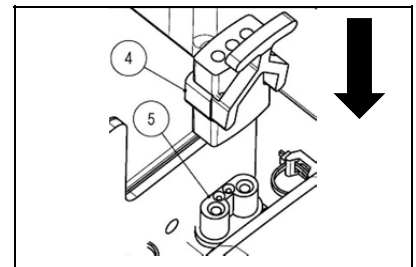

19. BATTERY CHARGER CONNECTION (B VERSIONS WITH BC)

In order not to cause permanent damage to the batteries, it is essential to avoid their complete discharge: arrange the recharge within a few minutes of the switching on of the "discharged batteries" blinking light.



ATTENTION: Never leave the batteries completely discharged, even if the machine is not being used. Check the battery charger is suitable for the batteries installed, in terms of both capacity and type.

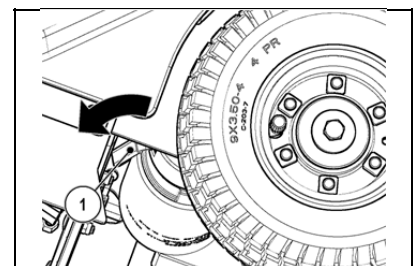



PREPARATION OF MACHINE

To connect the battery charger you must:

1. Move the machine to the place used for maintenance or recharging the batteries.
2. Make sure the electric brake is engaged, otherwise engage it using the lever (1) located at the left rear of the machine (working direction).
3. Check the main switch (2) is in the "0" position, if this is not the case, turn the key by a quarter of a turn to the left, and remove the key from the instrument panel.
4. Grasp the handle located on the side of the operator seat unit.
5. Lift the operator seat unit until the safety clamp (3) is hooked.

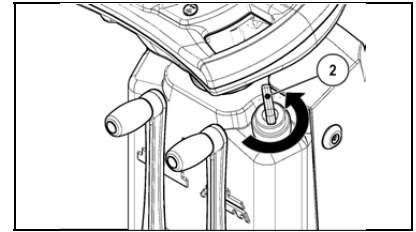

ATTENTION: Park the machine in an place protected from the weather and with suitable ventilation, and on a flat and level surface; near the machine there must be no objects that could either damage it, or be damaged through contact with it.

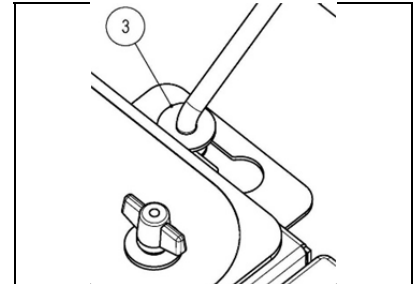

6. Remove the battery charger cover (4).
7. Connect the battery charger power cable connector to the socket on the charger itself. Before inserting the power cable into the socket of the charger, make sure that there is no condensate or other forms of liquids.
8. Plug the battery charger power cable into the mains socket.



ATTENTION: Carefully read the use and maintenance manual of the charger that is delivered inside the bag containing this instruction booklet.



ATTENTION: Keep the seat unit open for the duration of the battery recharging cycle to allow gas fumes to escape.

ATTENTION: the room used to recharge the batteries must be adequately ventilated to prevent the accumulation of gases that leak from batteries.

9. When the recharge cycle is complete, disconnect the battery charger cable from the mains.
10. Disconnect the battery charger power cable connector from the socket on the charger itself.

11. Replace the battery charger cover (4).
12. Grip the handle on the side of the operator seat unit and lower the seat unit until it is in the working position.



ATTENTION: if the machine's electric system is accidentally powered (by turning the main switch to "I"), the commands display will show "BATTERY-CHARGER" and no steering wheel command will function.

ATTENTION: Always make sure the green LED of the battery charger is on before using the machine again.

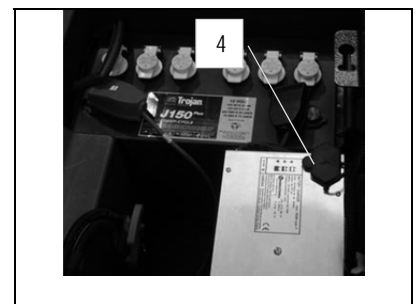



PREPARATION OF MACHINE

20. CONNECTING THE BATTERY CHARGER (HYBRID VERSIONS)

In order not to cause permanent damage to the batteries, it is essential they are fully charged using a suitable battery charger, after the non-use of the machine for a long period or after ten complete discharge cycles of the batteries.



ATTENTION: Never leave the batteries completely discharged, even if the machine is not being used. Check the battery charger is suitable for the batteries installed, in terms of both capacity and type.

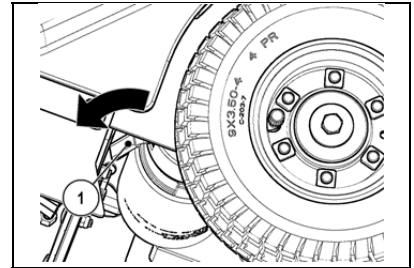

To connect the battery charger you must:

1. Move the machine near to the battery charger.
2. Make sure the electric brake is engaged, otherwise engage it using the lever (1) located at the left rear of the machine (working direction).
3. Check the main switch (2) is in the "0" position, if this is not the case, turn the key by a quarter of a turn to the left, and remove the key from the instrument panel.
4. Grasp the handle located on the side of the operator seat unit.
5. Lift the operator seat unit until the safety clamp (3) is hooked.

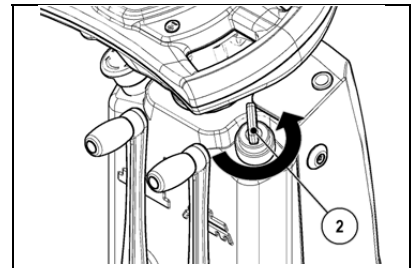

ATTENTION: Park the machine in a place protected from the weather and with suitable ventilation, and on a flat and level surface; near the machine there must be no objects that could either damage it, or be damaged through contact with it.

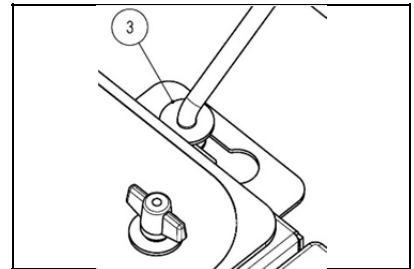

6. Check that the motor switch is in the "0" position, if this is not the case, turn the handle by a quarter of a turn to the left, and remove the key from the instrument panel.
7. Disconnect the electric system connector (4) from the battery connector (5).



ATTENTION: This process must be carried out by qualified personnel. An incorrect connection of the connector may cause problems with machine functioning.

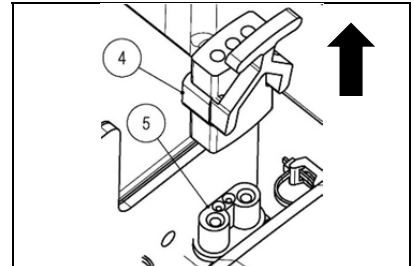

8. Connect the connector of the battery charger cable (6) to the battery connector (5).



ATTENTION: Keep the seat unit open for the duration of the battery recharging cycle to allow gas fumes to escape.
ATTENTION: the room used to recharge the batteries must be adequately ventilated to prevent the accumulation of gases that leak from batteries.

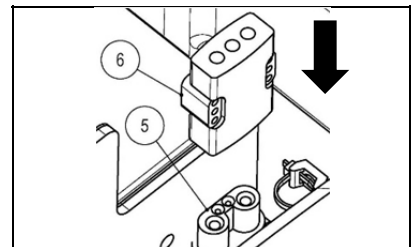

The coupling connector of the battery charger is supplied inside the bag containing this instruction booklet, and must be fitted to the battery charger cables as shown in the instructions.

9. Connect the recently wired cable to the external battery charger.



ATTENTION: carefully read the use and maintenance instructions of the battery charger that is used for charging.



PREPARATION OF MACHINE



ATTENTION: Danger of gas exhalation and leakage of corrosive liquids.



ATTENTION: Danger of fire: keep naked flames at a safe distance.

10. After the recharge cycle has completed, disconnect the battery charger connector from the external battery charger.

11. Disconnect the battery charger cable (6) from the battery connector (5).

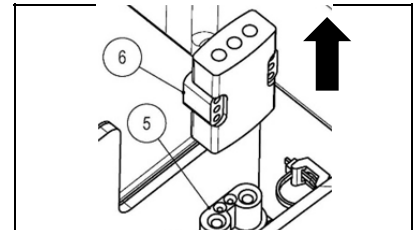

12. Connect the battery connector (5) to the electric system connector (4).

13. Grip the handle located on the side of the operator seat unit and lower the seat unit until it is in the working position.

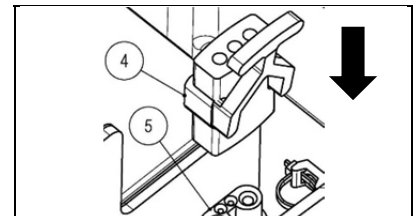

21. CHARGE LEVEL INDICATOR OF THE BATTERIES (B VERSIONS)

On the instrument panel of the machine there is a monitor (1) indicating (amongst other things) the battery charge status. If the lower line contains ten light indicators, the battery charge level is 100 %. If the battery charge percentage is at 00 % and flashing, this means the batteries are discharged.



ATTENTION: After a few seconds that the battery charge has reached 20 %, the central brush motor, the side brush/es motor, and the vacuum motor will turn off automatically. With the remaining charge, it is still possible, however, to move the machine to the location designated for recharging the batteries.

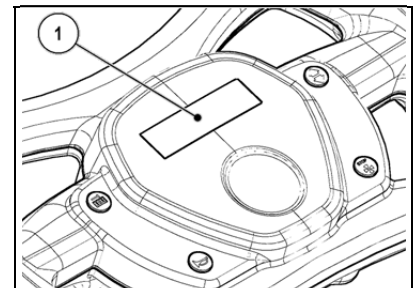

22. HOUR METER

On the machine's instrument panel there is a display (1) indicating the total machine usage time. The top line shows the hours and minutes of functioning. The flashing ":" symbol indicates that the hour meter is counting the machine functioning time.

23. ADVANCEMENT AT WORK SPEED

This machine is equipped with electronic traction control. To move the machine, after having turned the key in the "I" position, push the drive pedal (1) adjusting the speed by pressing and releasing the pedal. The machine will then start moving.



ATTENTION! The machine will not start to move (either forwards or backwards) if the electrical brake is not engaged. In this case, you will see "ELECTRICAL BRAKE?" on the command display.

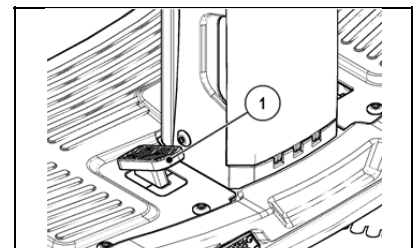

To move the machine backwards, press the button (2) on the instrument panel, then immediately press the pedal (1). Adjust the speed by altering the degree of pressure on the pedal.



ATTENTION! the reverse speed is lower than the forward speed to comply with current health and safety standards.

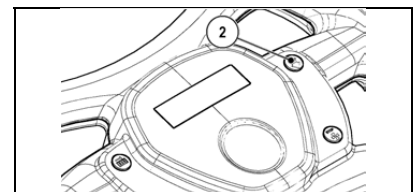



PREPARATION OF MACHINE

24. BLINKING LIGHT (OPTIONAL)

The machine can be equipped with a blinking light that turns on automatically when the key in the main switch is turned on.

25. FILLING THE FUEL TANK (HYBRID VERSIONS)

The machine is supplied without any fuel in the tank of the endothermic engine. To fill the tank, proceed as follows:

1. Make sure the electric brake is engaged, otherwise engage it using the lever (1) located at the left rear of the machine (working direction).
2. Check the main switch (2) is in the "0" position, if this is not the case, turn the key by a quarter of a turn to the left, and remove the key from the instrument panel.
3. Grasp the handle located on the side of the operator seat unit.
4. Lift the operator seat unit until the safety clamp (3) is hooked.

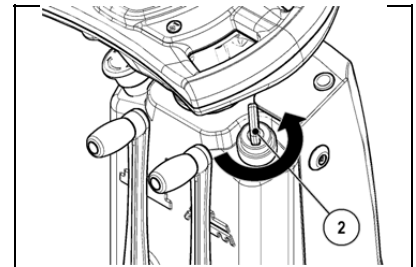
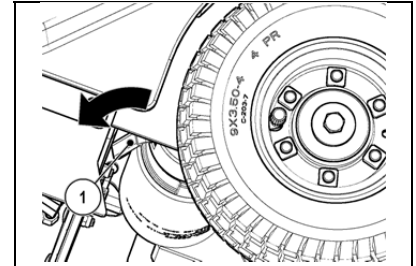

5. With regard to the safe filling of the combustion engine fuel tank, you must scrupulously observe the indications given in the combustion engine user manual (supplied with the machine).

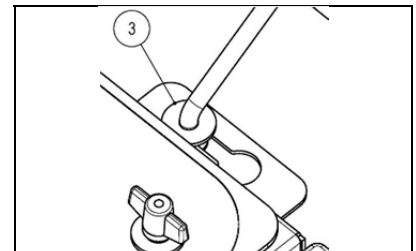

ATTENTION: The machine does not have a fuel level indicator, so you must always check the level before using it.

ATTENTION: Gasoline is highly inflammable and may explode.



ATTENTION: Top up the fuel in a well-ventilated area, with the engine switched off. Do not smoke or take any unprotected flames or sparks near the motor while it is being filled, or in the area where the gasoline is stored.

ATTENTION: During the filling operation, be careful not to spill the fuel. Spilt fuel or fuel vapours could ignite. If any fuel is accidentally spilt, remove it thoroughly before switching on the engine.

26. HEADLIGHTS

The machine has headlights that turn on automatically when the main switch is turned to "I" or "II".



PREPARING TO WORK

27. PREPARING TO WORK (B VERSIONS)

Before beginning to work, it is necessary to:

1. Ensure that the debris hopper is empty, otherwise empty it completely (see paragraph "EMPTYING THE DEBRIS HOPPER").
2. Check that the condition of the central brush is suitable for the work, otherwise arrange for its maintenance (see paragraph "CLEANING THE BRUSH CENTRAL" or "CENTRAL BRUSH REPLACEMENT").
3. Check that the condition of the side brush (version 1SL or brushes version 2SL) is suitable for the work, otherwise arrange for their maintenance (see paragraph "CLEANING THE SIDE BRUSH" or "SIDE BRUSH REPLACEMENT").
4. Make sure the electric brake is engaged, otherwise engage it using the lever (1) located at the left rear of the machine (working direction).
5. Check the main switch (2) is in the "0" position, if this is not the case, turn the key by a quarter of a turn to the left, and remove the key from the instrument panel.
6. Make sure the emergency switch is in the OFF position.
7. Grasp the handle located on the side of the operator seat unit.
8. Lift the operator seat unit until the safety clamp (3) is hooked.
9. Connect the connector of the machine (4) to the battery connector (5).
10. Grip the handle on the side of the operator seat unit and lower the seat unit until it is in the working position.

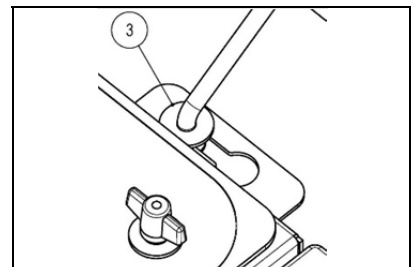
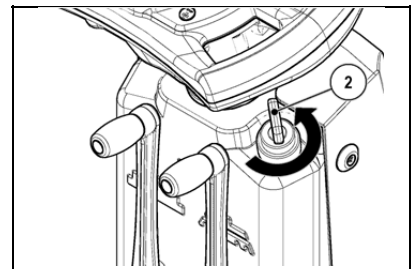
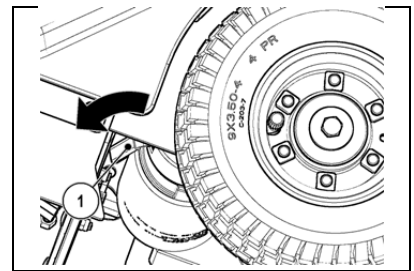



PREPARING TO WORK

28. PREPARING TO WORK (HYBRID VERSIONS)

Before beginning to work, it is necessary to:

1. Ensure that the debris hopper is empty, otherwise empty it completely (see paragraph "EMPTYING THE DEBRIS HOPPER").
2. Check that the condition of the central brush is suitable for the work, otherwise arrange for its maintenance (see paragraph "CLEANING THE BRUSH CENTRAL" or "CENTRAL BRUSH REPLACEMENT").
3. Check that the condition of the brush (version 1SL or brushes version 2SL) is suitable for the work, otherwise arrange for their maintenance (see paragraph "CLEANING THE SIDE BRUSH" or "SIDE BRUSH REPLACEMENT").
4. Make sure the electric brake is engaged, otherwise engage it using the lever (1) located at the left rear of the machine (working direction).
5. Check the main switch (2) is in the "0" position, if this is not the case, turn the key by a quarter of a turn to the left, and remove the key from the instrument panel.
6. Make sure the emergency switch is in the OFF position.
7. Grasp the handle located on the side of the operator seat unit.
8. Lift the operator seat unit until the safety clamp (3) is hooked.
9. Connect the connector of the machine (4) to the battery connector (5).
10. Grip the handle on the side of the operator seat unit and lower the seat unit until it is in the working position.
11. Perform all the required checks prior to using the combustion engine, following the instructions given in the user manual of the combustion engine (supplied with the machine).
12. Having completed the controls of the combustion engine, grasp of the handle located on the side of the operator seat unit and lower the seat unit until it is in the working position.

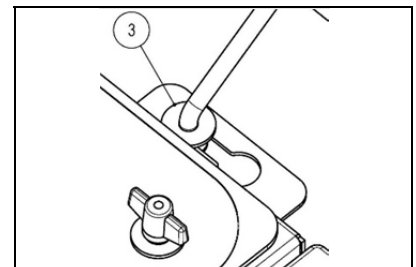
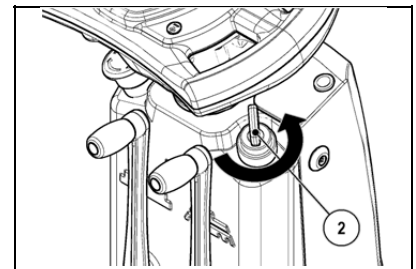
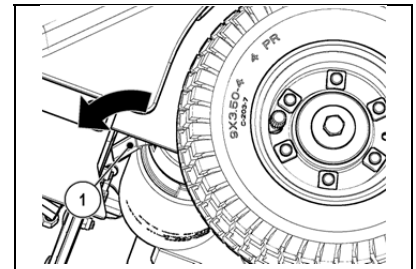



WORK

29. STARTING WORK (B VERSIONS)

To start working, do as follows:

1. Carry out all controls indicated in paragraph "PREPARING TO WORK (B VERSIONS)".
2. Sit on the driver's seat.
3. Turn the main switch key (1) clockwise by a quarter of a turn to position "I". The control display on the instrument panel will immediately come on.
4. When the display comes on, three screens appear in sequence. The first screen displayed indicates the name of the machine.
5. The second screen shows the total functioning time on the top line. On the bottom line, the release of the program and the battery technology that has been set for the operation of the machine, in this case gel batteries are used.
6. The third and last screen (known as "work") displays the battery charge status and the total functioning time. When the batteries supplied are fully charged, the bottom line contains ten light indicators that represent a battery. As the batteries gradually run down, the indicators go out and, with the batteries completely run down, only the battery outline flashes. The top line indicates the hours and minutes of functioning. The flashing ":" symbol indicates that the hour meter is counting the machine functioning time.
7. Lower the central brush until it is in contact with the ground, rotating the lever (2) clockwise.

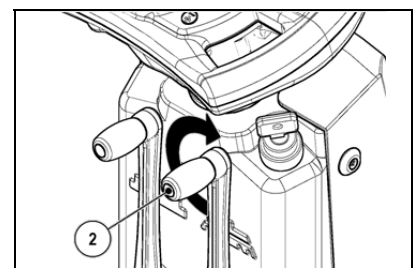
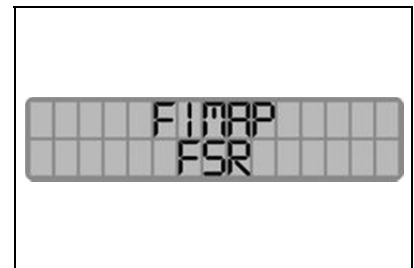
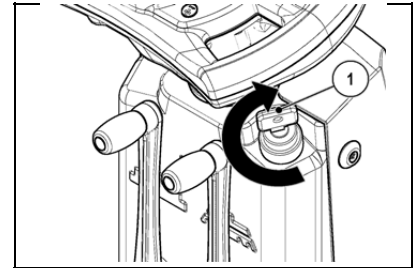

8. Pressing the forward pedal (3), the machine will begin to move.

As soon the forward pedal is pushed, the motor of the central brush and the vacuum motor will start working. The machine will now work at its maximum efficiency level until the batteries run down.

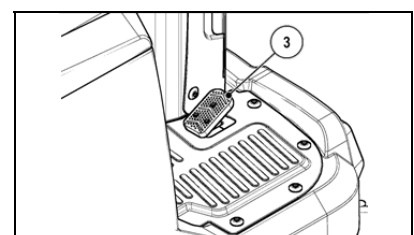



WORK

If the machine does not move and the control display shows "ELECTRO-BRAKE?" the electric brake has to be engaged, using the lever on the rear left of the machine (work direction).

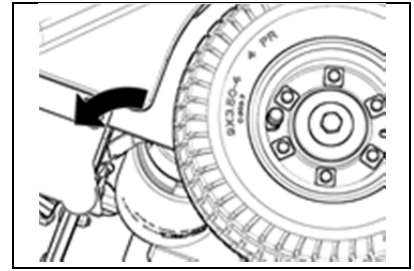

To lower the right side brush (1SL versions) or both side brushes (2SL versions) simply turn the lever (4) clockwise.



ATTENTION: use the side brush or brushes (according to machine version) only on edges, as it is not assisted by the vacuum action

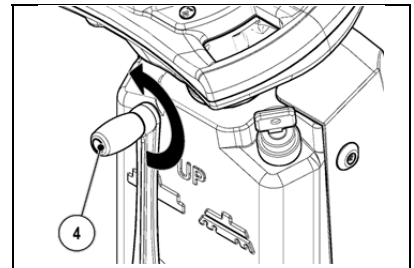

Deactivate the vacuum motor when you are about to clean wet or damp surfaces, to avoid ruining the filter. To turn off the vacuum motor, press button (5) on the control handlebar.



ATTENTION: As soon as button (5) is pressed the control display shows the message "VACUUM OFF". To re-activate the vacuum, press button (5).

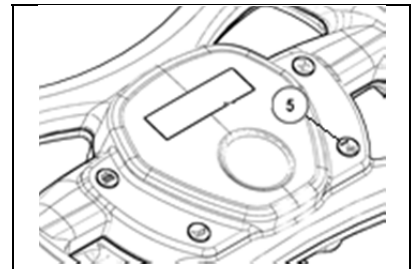

Press the front flap-raiser pedal (6) when working with bulky waste, to allow the central brush to reach and collect it.



ATTENTION: Do not hold the pedal for long.

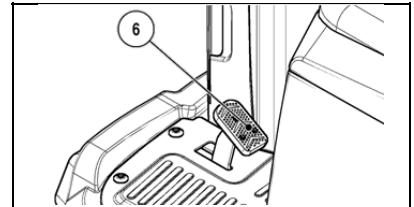

In order to achieve a correct vacuum action, clean the filter every 10 minutes and always before any discharge of the debris hopper.

To do this, proceed as follows:

1. Lift the central brush by turning the right lever (2) anti-clockwise.
2. Lift the side brush if lowered, by rotating the left lever (4) clockwise.
3. Activate the filter shaker by pressing the button (7) on the control handlebar, the vacuum automatically terminates.

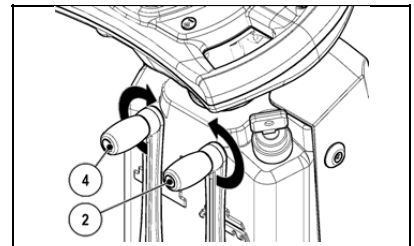

ATTENTION: As soon as the central brush is lifted from the ground, the vacuum motor automatically turns off.

ATTENTION: As soon as the filter shaker button is pressed, the vacuum motor will turn off automatically.

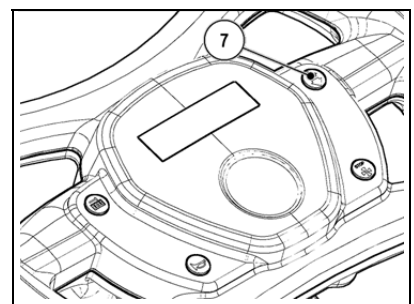

Periodically check the filling of the tray and if necessary proceed to empty it. Keep in mind that the weight of the waste collected is proportional to the specific weight of the material swept. In the case of heavy material such as sand, earth, gravel, etc. the tray should ideally not be filled more than 70 %, otherwise it may be difficult to empty.



WORK

30. STARTING WORK (HYBRID VERSIONS)

To start working in battery mode, proceed as follows:

1. Carry out all controls indicated in paragraph "PREPARING TO WORK (HYBRID VERSIONS)".
2. Sit on the driver's seat.
3. Turn the key (1) of the main switch until it is in position "I", in this case the type of power supply of the machine is battery-powered. The control display on the instrument panel will immediately come on.

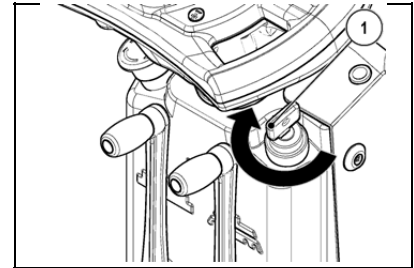

ATTENTION: The battery power is particularly suitable for the cleaning of closed environments, where inhalation of the exhaust gases of the combustion engine would be harmful.

4. When the display comes on, three screens appear in sequence. The first screen displayed indicates the name of the machine.
5. The second screen shows the total functioning time on the top line. On the bottom line, the release of the program and the battery technology that has been set for the operation of the machine, in this case gel batteries are used.
6. The third and last screen (known as "work") displays the battery charge status and the total functioning time. When the batteries supplied are fully charged, the bottom line contains ten light indicators that represent a battery. As the batteries gradually run down, the indicators go out and, with the batteries completely run down, only the battery outline flashes. The top line indicates the hours and minutes of functioning. The flashing ":" symbol indicates that the hour meter is counting the machine functioning time.
7. Lower the central brush until it is in contact with the ground, rotating the lever (2) clockwise.

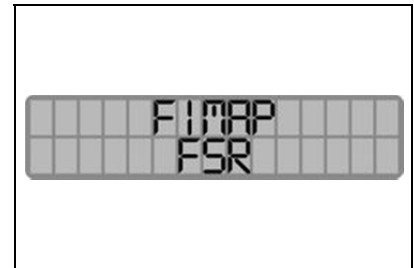

8. Pressing the forward pedal (3), the machine will begin to move.

As soon the forward pedal is pushed, the motor of the central brush and the vacuum motor will start working. The machine will now work at its maximum efficiency level until the batteries run down.

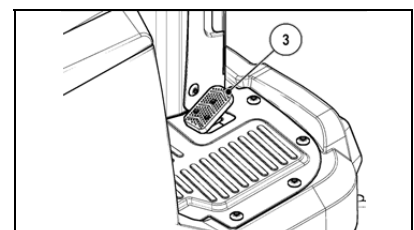
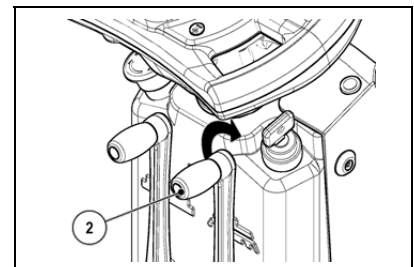



WORK

If the machine does not move and the control display shows "ELECTRO-BRAKE?" the lever on the rear left of the machine (work direction) is used to activate it.

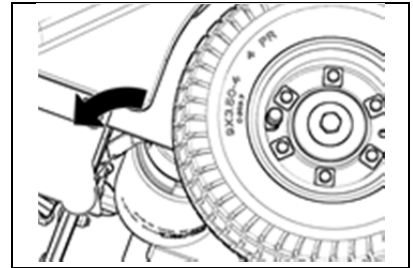

To lower the right side brush (1SL versions) or both side brushes (2SL versions) simply turn the lever (4) clockwise.



ATTENTION: use the side brush or brushes (according to machine version) only on edges, as it is not assisted by the vacuum action.

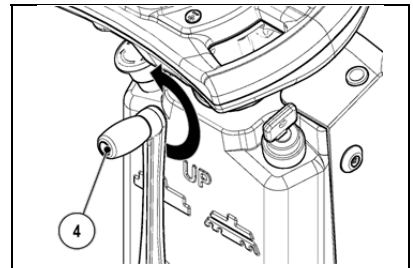

Deactivate the vacuum motor when you are about to clean wet or damp surfaces, to avoid ruining the filter. To turn off the vacuum motor, press button (5) on the control handlebar.



ATTENTION: As soon as button (5) is pressed the control display shows the message "VACUUM OFF". To re-activate the vacuum, press button (5).

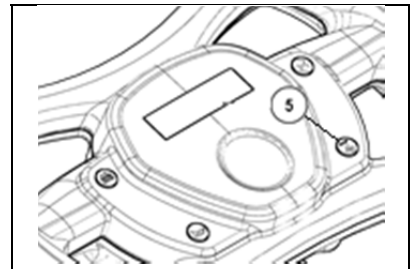

Press the front flap-raiser pedal (6) when working with bulky waste, to allow the central brush to reach and collect it.



ATTENTION: Do not hold the pedal for long.

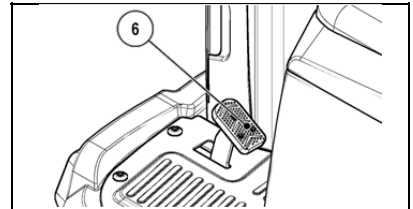

In order to achieve a correct vacuum action, clean the filter every 10 minutes and always before any discharge of the debris hopper.

To do this, proceed as follows:

1. Lift the central brush by turning the right lever (2) anti-clockwise.
2. Lift the side brush if lowered, by rotating the left lever (4) clockwise.
3. Activate the filter shaker by pressing the button (7) on the control handlebar, the vacuum automatically terminates.

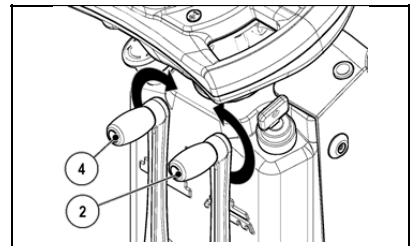

ATTENTION: As soon as the central brush is lifted from the ground, the vacuum motor automatically turns off.

ATTENTION: As soon as the filter shaker button is pressed, the vacuum motor will turn off automatically.

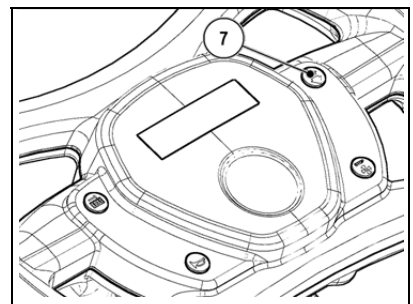

Periodically check the filling of the tray and if necessary proceed to empty it. Keep in mind that the weight of the waste collected is proportional to the specific weight of the material swept. In the case of heavy material such as sand, earth, gravel, etc. the tray should ideally not be filled more than 70 %, otherwise it may be difficult to empty.



WORK

ATTENTION: Use the machine until the battery is complete discharged.

ATTENTION: Never leave the batteries completely discharged, even if the machine is not being used.



ATTENTION: If the machine is not used for a long period of time, perform a complete charging cycle of batteries. Use a battery charger suitable for the batteries installed both for the capacity and the type.

ATTENTION: Perform a complete charging cycle every ten cycles of full discharge of the batteries. Use a battery charger suitable for the batteries installed both for the capacity and the type.

To start working in hybrid mode, proceed as follows:

1. Carry out all controls indicated in paragraph "PREPARING TO WORK (HYBRID VERSIONS)".
2. Sit on the driver's seat.
3. Turn the key (1) of the main switch until it is in position "II", in this case the type of power supply of the machine is the combustion engine.
4. When the display comes on, three screens appear in sequence. The first screen displayed indicates the name of the machine.

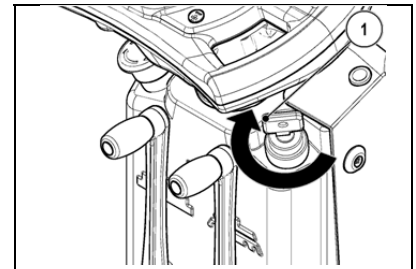

5. The second screen shows the total functioning time on the top line. On the bottom line, the battery technology that has been set for the operation of the machine and the release of the program.
6. The third screen displays the wording "START ENGINE"; perform all the procedures to start the combustion engine.

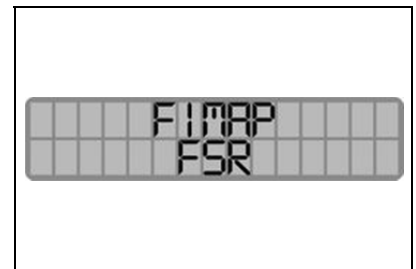

ATTENTION: Follow the instructions given in the user manual of the combustion engine (supplied with the machine).

ATTENTION: The type of power with combustion engine is particularly suitable for the cleaning of outside or well ventilated environments, where the exhaust gases of the combustion engine would not be harmful.

ATTENTION: As soon as the engine speed is stabilized, move the throttle lever on the combustion engine to maximize.

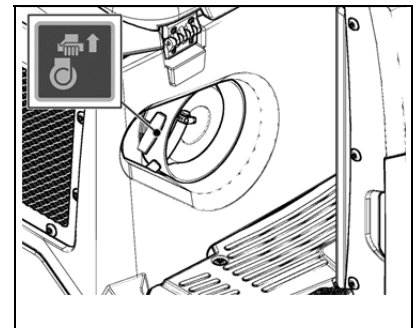

7. The fourth and final screen called "work" displays the total operating time. The top line shows the operating hours and minutes and the flashing symbol ":" indicates that the hour meter is counting the machine functioning time. The bottom line contains ten light indicators





WORK

8. Lower the central brush until it is in contact with the ground, rotating the lever (2) clockwise.

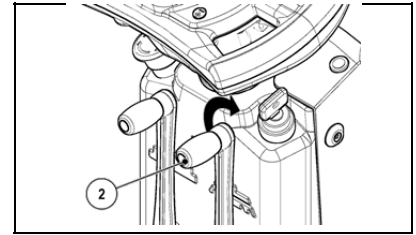

9. Pressing the forward pedal (3), the machine will begin to move.

As soon the forward pedal is pushed, the motor of the central brush and the vacuum motor will start working. The machine will now work at its maximum efficiency level until the batteries run down.

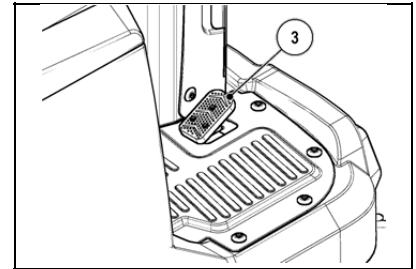

If the machine does not move and the control display shows "ELECTRO-BRAKE?" the electric brake has to be engaged, using the lever on the rear left of the machine (work direction).

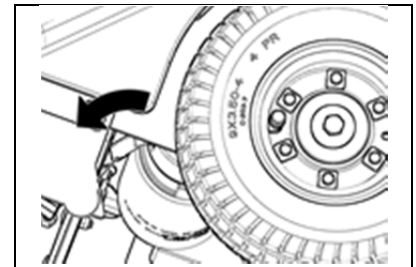

To lower the right side brush (1SL versions) or both side brushes (2SL versions) simply turn the lever (4) clockwise.



ATTENTION: use the side brush or brushes (according to machine version) only on edges, as it is not assisted by the vacuum action.

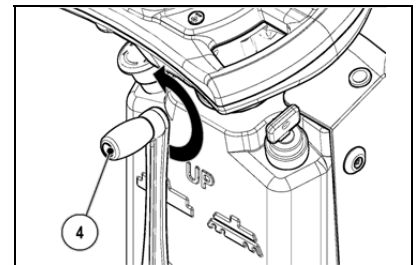

Deactivate the vacuum motor when you are about to clean wet or damp surfaces, to avoid ruining the filter, and be careful not to operate the filter shaker while the vacuum motor is turned off. To turn off the vacuum motor, press button (5) on the control handlebar.



ATTENTION: As soon as button (5) is pressed the control display shows the message "VAC OFF". To re-activate the vacuum, press button (5).

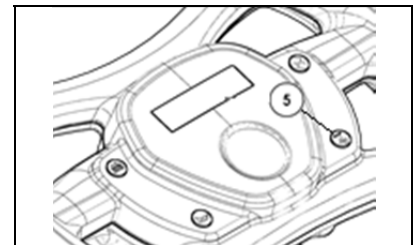

Press the front flap-raiser pedal (6) when working with bulky waste, to allow the central brush to reach and collect it.



ATTENTION: Do not hold the pedal for long.

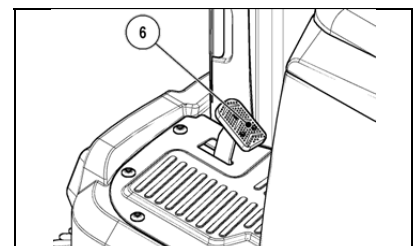



WORK

In order to achieve a correct vacuum action, clean the filter every 10 minutes and always before any discharge of the debris hopper.

To do this, proceed as follows:

1. Lift the central brush by turning the left lever (2) clockwise.
2. Lift the side brush if lowered, by rotating the right lever (4) clockwise.

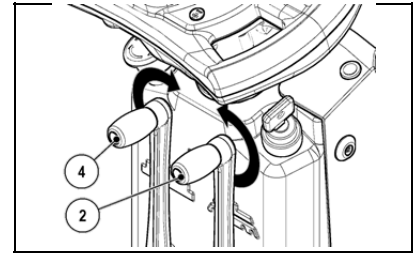

3. Activate the filter shaker by pressing the button (7) on the control handlebar, the vacuum automatically terminates.

Periodically check the filling of the tray and if necessary proceed to empty it. Keep in mind that the weight of the waste collected is proportional to the specific weight of the material swept. In the case of heavy material such as sand, earth, gravel, etc. the tray should ideally not be filled more than 70 %, otherwise it may be difficult to empty.

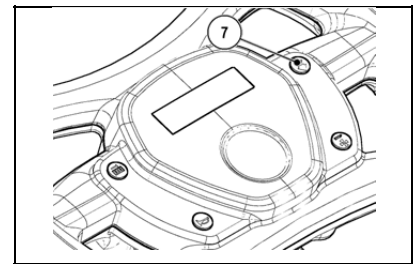

The Hybrid machine in combustion engine mode must be used in outdoor or highly ventilated environments. The combustion engine mode guarantees the recharging of the batteries supplied with the machine, allowing to increase the duration of the work, but there is not a device that warns that the batteries are fully recharged.



ATTENTION: The transition from battery to hybrid must be performed at a standstill.

31. EMERGENCY BUTTON

If there are any problems while you are working, press the emergency button (1) beneath the seat (B versions) or on the steering column (Hybrid versions). This command interrupts the electric circuit between the batteries and the machine system, so the machine stops and the electric brake is triggered. To resume work, having solved the problem, proceed as follows:

1. Rotate the key (2) of the main switch to the "0" position.
2. Move button (1) to the standard position
3. Turn the key (2) of the main switch to "I" or "II", depending on the type of power source you want to use.

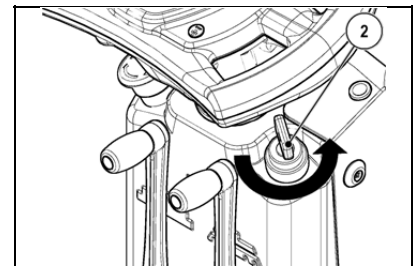

ATTENTION: The images refer to the Hybrid version.

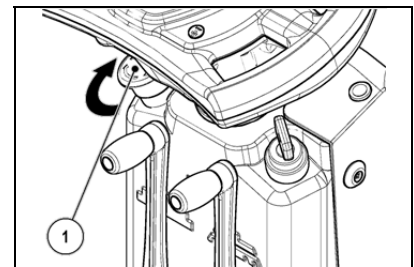

32. ALTERNATOR FAULT WARNING LIGHT (HYBRID VERSIONS)

If there are problems with the operation of the alternator when working with combustion engine mode (Hybrid versions), the red warning light (1) on the steering column lights. Move the machine to the maintenance area and contact the specialised assistance centre.



ATTENTION: As soon as the red warning light (1) is activated, stop the machine and contact the assistance centre.

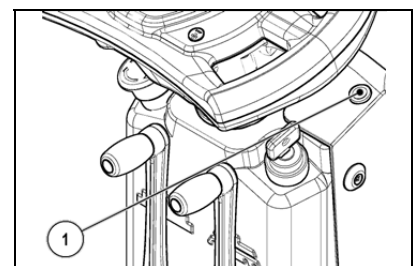



WORK

33. EMPTYING THE DEBRIS HOPPER

The machine is NOT equipped with a device to warn you when the debris hopper is full, so it is a good idea to empty it frequently while working. In order to empty the debris hopper, proceed as follows:

1. Stop the machine close to the place where the debris hopper is emptied.
2. Lift the central brush by turning the lever (1) anti-clockwise.
3. Lift the side brush if lowered, by rotating the lever (2) clockwise.
4. Activate the filter shaker by intermittently pressing the button (3) on the control handlebar, the vacuum automatically terminates.



ATTENTION! Do not keep the switch (3) pressed longer than ten seconds; repeat this operation two or three times.

5. Rotate the key (4) of the main switch to the "0" position.

6. Turn the latches (5) in order to release the debris hopper, turn the left latch counter-clockwise and the right latch clockwise.



ATTENTION: users are advised to always wear protective gloves, to avoid the risk of serious injury to hands.

7. Grasping the handle (6) on the debris hopper, remove it from the machine.
8. Take the debris hopper to the appropriate location for unloading and empty it.

9. Grasping the handle (6) on the debris hopper, and assemble it on the machine.

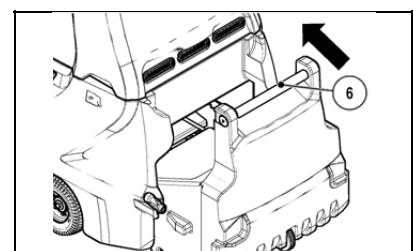
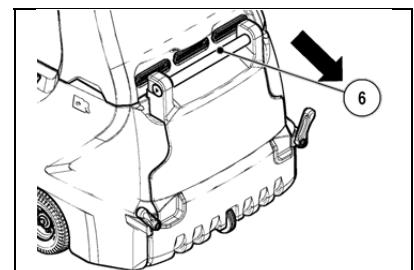
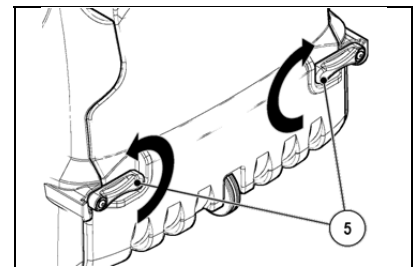
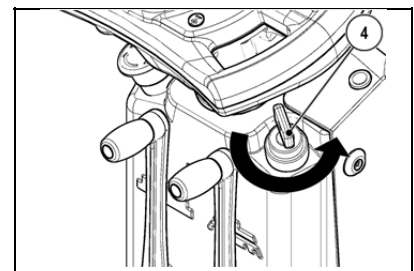
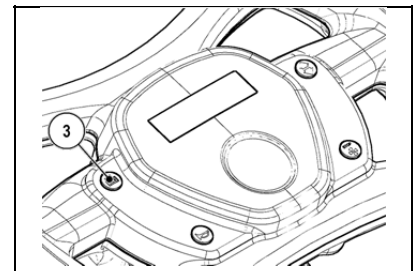
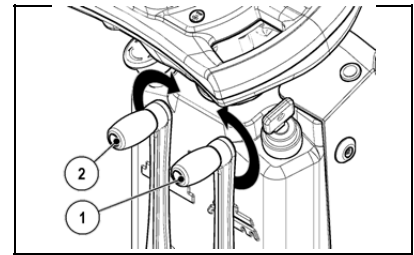



WORK

10. Turn the latches (5) to secure the debris hopper to the body, turn the left latch clockwise and the right latch counter-clockwise.

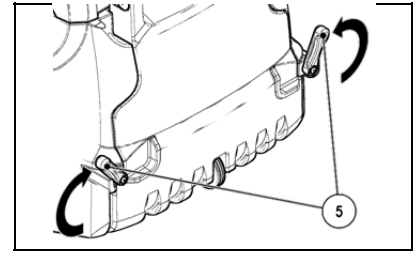



AT THE END OF THE WORK

At the end of the work, and before carrying out any type of maintenance, perform the following operations:

1. Stop the machine close to the place where the debris hopper is emptied.
2. Lift the central brush by turning the lever (1) anti-clockwise.
3. Lift the side brush if lowered, by rotating the lever (2) clockwise.

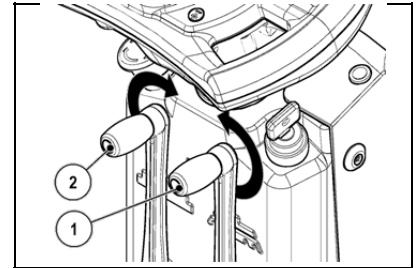

4. Activate the filter shaker by intermittently pressing the button (3) on the control handlebar, the vacuum automatically terminates.



ATTENTION! Do not keep the switch (3) pressed longer than ten seconds; repeat this operation two or three times.

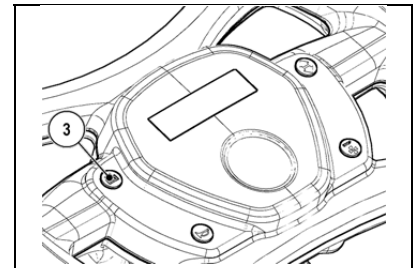

5. Rotate the key (4) of the main switch to the "0" position.

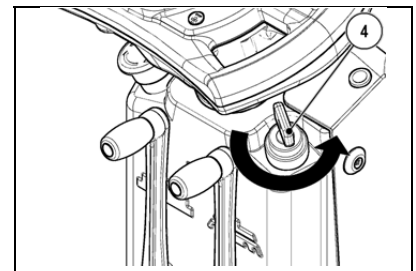

6. Turn the latches (5) in order to release the debris hopper, turn the left latch counter-clockwise and the right latch clockwise.



ATTENTION: users are advised to always wear protective gloves, to avoid the risk of serious injury to hands.

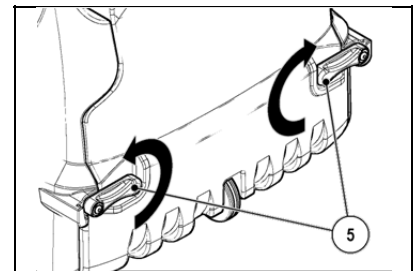

7. Grasping the handle (6) on the debris hopper, remove it from the machine.
8. Take the debris hopper to the appropriate location for unloading and empty it.



ATTENTION! Periodically check that the sealing ring of the debris hopper and of the frame, if it is worn or damaged replace it immediately.

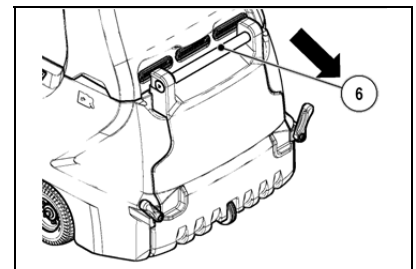

9. Grasping the handle (6) on the debris hopper, and assemble it on the machine.

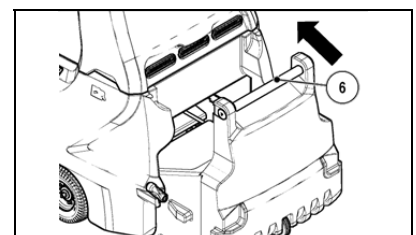



AT THE END OF THE WORK

10. Turn the latches (5) to secure the debris hopper to the body, turn the left latch clockwise and the right latch counter-clockwise.

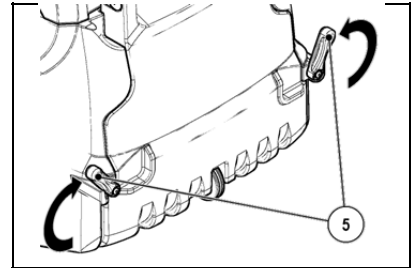

11. Turn the key (4) of the main switch to "I" or "II", depending on the type of power source you want to use.
12. Take the machine to the designated machine storage place.



ATTENTION: Park the machine in an enclosed place, on a flat surface; near the machine there must be no objects that could either damage it, or be damaged through contact with it.

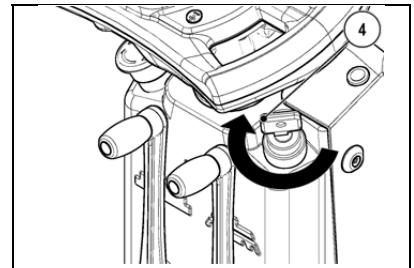

13. Rotate the key (4) of the main switch to the "0" position.
14. Remove the key from the controls instrument panel.

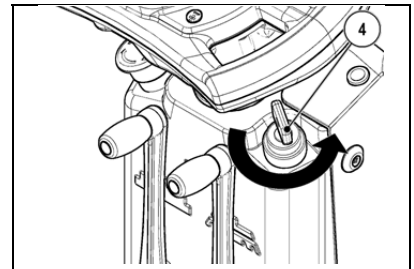

15. Grasp the handle located on the side of the operator seat unit.
16. Lift the operator seat unit until the safety clamp (7) is hooked.

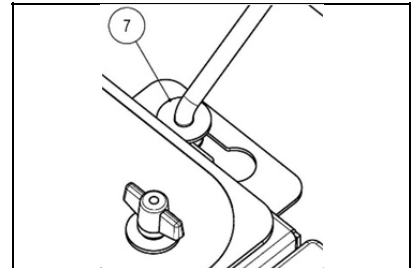

17. Disconnect the connector of the electric system (8) from the battery connector (9).



ATTENTION: This process must be carried out by qualified personnel. An incorrect connection of the connector may cause problems with machine functioning.

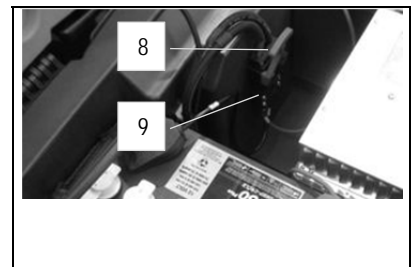

The adjacent figure shows the battery powered machine.

18. For Hybrid versions only, turn switch (10) on the combustion engine to the "OFF" position.

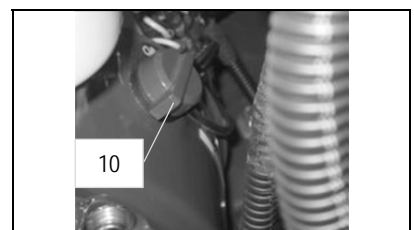



DAILY MAINTENANCE

PERFORM ALL MAINTENANCE OPERATIONS IN SEQUENCE

34. CLEANING THE CENTRAL BRUSH

Proceed as follows in order to clean the central brush:

1. Make sure the electric brake is engaged, otherwise engage it using the lever located at the left rear of the machine (working direction).
2. Check the main switch (1) is in the "0" position, if this is not the case, turn the key by a quarter of a turn to the left, and remove the key from the instrument panel.

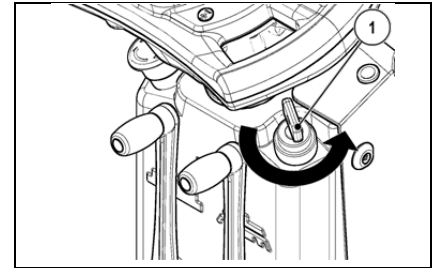

3. Check that the central brush is lifted from the ground, otherwise turn the lever (2) counter-clockwise.



ATTENTION: users are advised to always wear protective gloves, to avoid the risk of serious injury to hands.

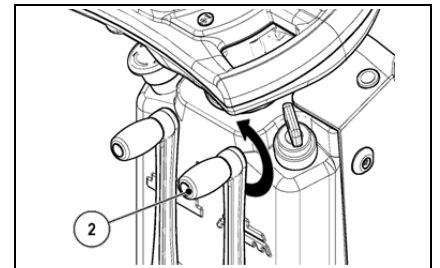

4. Open the left cover (3) (depending on the direction of travel).
5. Remove the knobs (4) securing the left casing of the brush, turning them counter-clockwise.

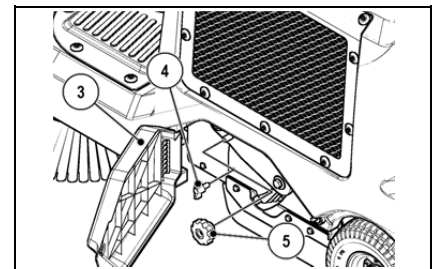

6. Remove the knob (5) that secures the lifting arm of the brush, by turning it counter-clockwise.
7. Remove the lifting arm (6) and the left side casing (7) of the brush.

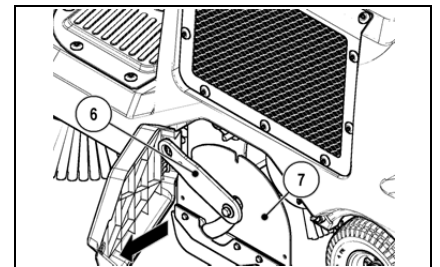

8. Remove the brushes from the tunnel.
9. Clean the brush under running water and remove any impurities present in the bristles of the brush.

Check the bristles. If they are excessively worn, replace the brushes (the bristles should protrude by at least 10 mm). Read paragraph "CENTRAL BRUSH REPLACEMENT" to replace the brush.

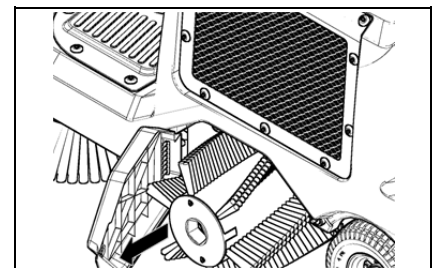

10. Repeat the operations in reverse order to reassemble all the parts.



ATTENTION: The brush must have the cusp facing towards the front of the machine to be fitted in the correct manner.



DAILY MAINTENANCE

35. CLEANING THE SIDE BRUSH

Proceed as follows in order to clean the side brush:

1. Make sure the electric brake is engaged, otherwise engage it using the lever located at the left rear of the machine (working direction).
2. Check the main switch (1) is in the "0" position, if this is not the case, turn the key by a quarter of a turn to the left, and remove the key from the instrument panel.

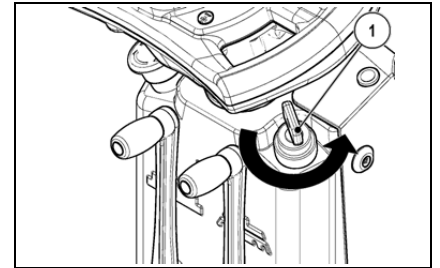

3. Check that the side brush is lifted from the ground, otherwise turn the lever (2) clockwise.



ATTENTION: users are advised to always wear protective gloves, to avoid the risk of serious injury to hands.

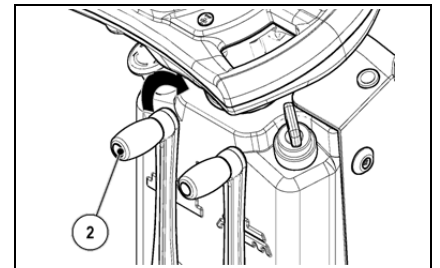

4. Remove knob (3) fixing the side brush to the gear motor by rotating clockwise the right brush and counter-clockwise the left brush.
5. Remove the side brush locking washer (4).

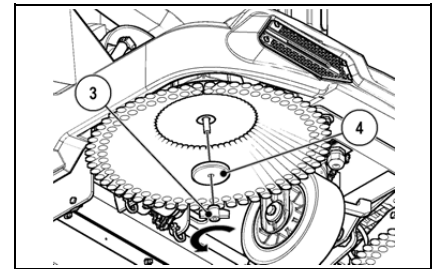

6. Remove the side brush.
7. Clean the brush under running water and remove any impurities present in the bristles of the brush.

Check the bristles are not worn; in the event of excessive wear, replace the brushes. Read paragraph "SIDE BRUSH REPLACEMENT" to replace the brush.

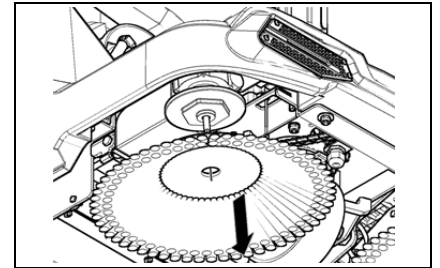

8. Repeat the operations in reverse order to reassemble all the parts.



WEEKLY MAINTENANCE

36. CLEANING THE PANEL FILTER

Whenever the vacuum action seems to be unsatisfactory, check that the vacuum filter is not obstructed. If necessary clean with an air jet as follows:

1. Make sure the electric brake is engaged, otherwise engage it using the lever located at the left rear of the machine (working direction).
2. Check the main switch (1) is in the "0" position, if this is not the case, turn the key by a quarter of a turn to the left, and remove the key from the instrument panel.
3. Grasp the handle located on the side of the operator seat unit.
4. Lift the operator seat unit until the safety clamp (2) is hooked.



ATTENTION: users are advised to always wear protective gloves, to avoid the risk of serious injury to hands.

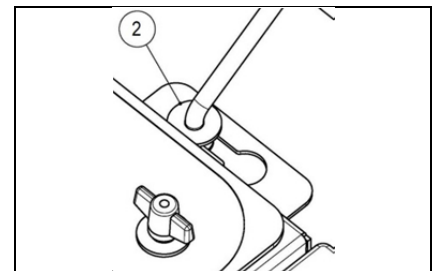
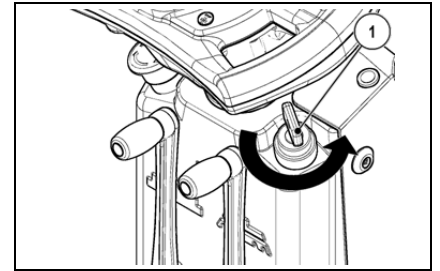

5. Disconnect the connector (3) of the vacuum motor.

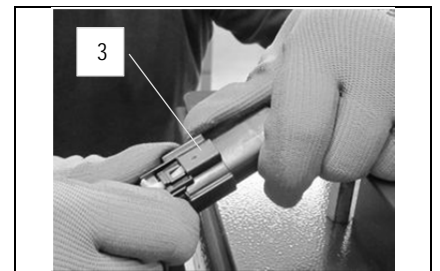

6. Remove the knobs (4) that secure the vacuum system assembly to the machine frame, by turning them counter-clockwise.
7. Remove the vacuum system assembly from the machine frame using the handles (5).

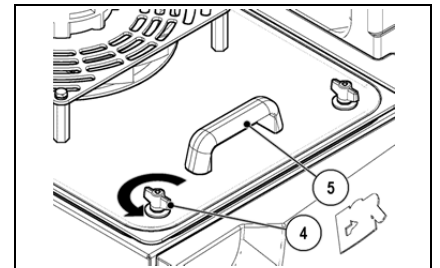

8. Remove the knobs (6) that secure the latch to the machine frame, by turning them counter-clockwise.
9. Remove the latch and consequently the panel filter from the machine.

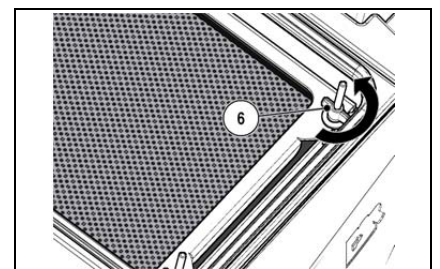

10. Clean the panel filter with an air jet from a distance of more than 20 cm.
11. Repeat the operations in reverse order to reassemble all the parts.



ATTENTION: It is advisable to pay attention to the direction of filtration, the mesh in the filter should be positioned towards the vacuum motor.



WEEKLY MAINTENANCE

37. CLEANING THE FABRIC FILTER (OPTIONAL)

Whenever the vacuum action seems to be unsatisfactory, check that the vacuum filter is not obstructed. If necessary clean with an air jet as follows:

1. Make sure the electric brake is engaged, otherwise engage it using the lever located at the left rear of the machine (working direction).
2. Check the main switch (1) is in the "0" position, if this is not the case, turn the key by a quarter of a turn to the left, and remove the key from the instrument panel.
3. Grasp the handle located on the side of the operator seat unit.
4. Lift the operator seat unit until the safety clamp (2) is hooked.



ATTENTION: users are advised to always wear protective gloves, to avoid the risk of serious injury to hands.

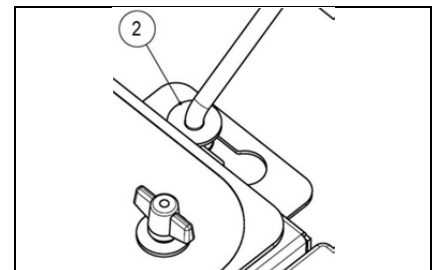
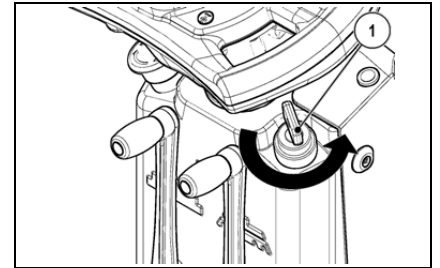

5. Disconnect the connector (3) of the vacuum motor.



6. Remove the knobs (4) that secure the vacuum system assembly to the machine frame, by turning them counter-clockwise.
7. Remove the vacuum system assembly from the machine frame using the handles (5).

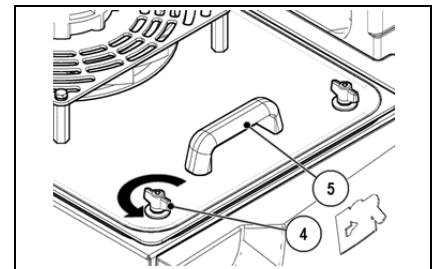

8. Remove the knobs (6) that secure the fabric filter assembly to the machine frame, by turning them counter-clockwise.
9. Remove the latch and as a result the fabric filter assembly from the machine frame, and be sure to disconnect the connector (7) of the filter shaker.

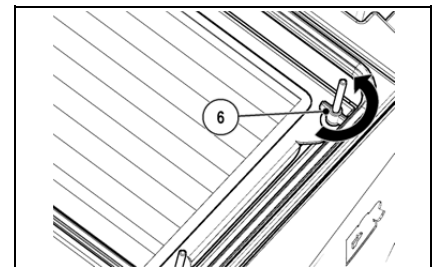

10. Clean the cloth filter with an air jet from a distance of more than 20 cm.
11. Repeat the operations in reverse order to reassemble all the parts.

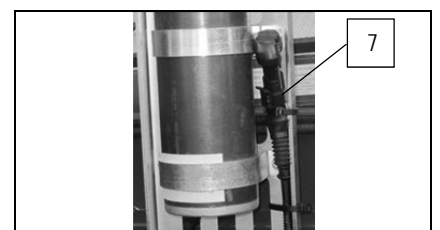



WEEKLY MAINTENANCE

38. CLEANING THE DEBRIS HOPPER

Clean the debris hopper every week as follows:

1. Make sure the electric brake is engaged, otherwise engage it using the lever located at the left rear of the machine (working direction).
2. Check the main switch (1) is in the "0" position, if this is not the case, turn the key by a quarter of a turn to the left, and remove the key from the instrument panel.
3. Turn the latches (2) in order to release the debris hopper, turn the left latch counter-clockwise and the right latch clockwise.



ATTENTION: users are advised to always wear protective gloves, to avoid the risk of serious injury to hands.

4. Grasping the handle (3) on the debris hopper, remove it from the machine.
5. Clean the debris hopper under running water and remove any impurities.

6. Grasping the handle (3) on the debris hopper, and assemble it on the machine.

7. Turn the latches (2) to secure the debris hopper to the body, turn the left latch clockwise and the right latch counter-clockwise.

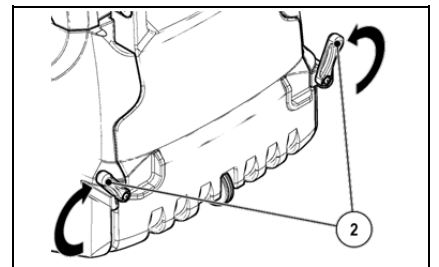
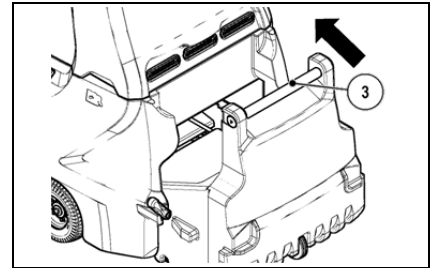
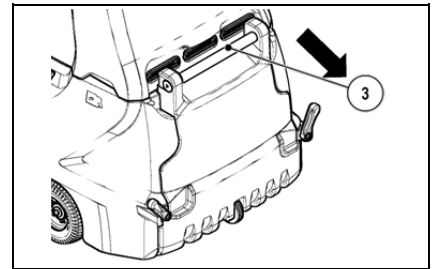
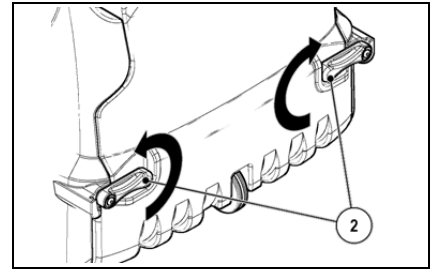
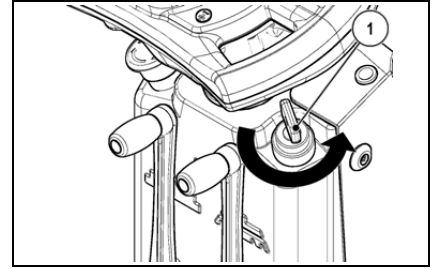



EMERGENCY MAINTENANCE

39. SIDE BRUSH ADJUSTMENT

If the side brush does not channel the dirt efficiently towards the centre of the machine, you must adjust its height in relation to the ground, as follows:

1. Make sure the electric brake is engaged, otherwise engage it using the lever located at the left rear of the machine (working direction).
2. Check the main switch (1) is in the "0" position, if this is not the case, turn the key by a quarter of a turn to the left, and remove the key from the instrument panel.
3. Check that the side brush lays flat on the ground, otherwise turn the lever (2) anticlockwise.



ATTENTION: users are advised to always wear protective gloves, to avoid the risk of serious injury to hands.

4. Loosen the counter nut (3) using the correct tool.
5. Using a suitable tool, loosen the adjustment screw (4) until the brush bristles are pressed onto the floor by about 2 cm.

6. Fix the counter nut (3) by using the right equipment.

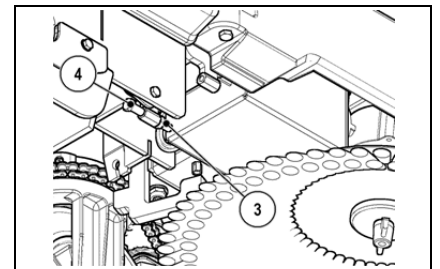
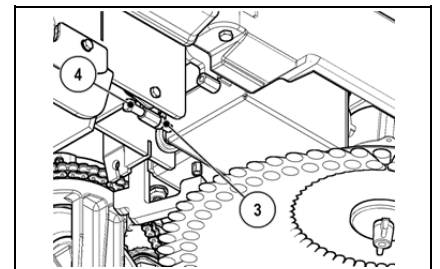
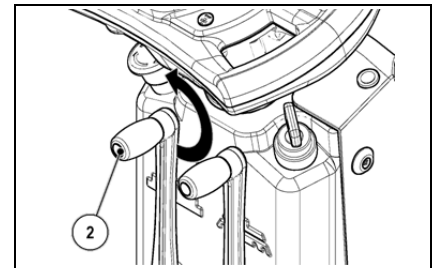
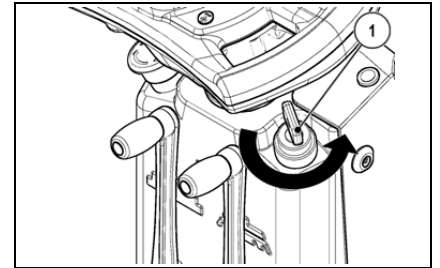

40. CENTRAL BRUSH FLAP ADJUSTMENT

If during working you notice that the machine leaves a trail of dust or dirt in its wake, this means that the flaps of the central brush need adjusting. Proceed as follows to adjust them:

1. Make sure the electric brake is engaged, otherwise engage it using the lever located at the left rear of the machine (working direction).
2. Check the main switch (1) is in the "0" position, if this is not the case, turn the key by a quarter of a turn to the left, and remove the key from the instrument panel.
3. Check that the central brush is lifted from the ground, otherwise turn the lever (2) counter-clockwise.



ATTENTION: users are advised to always wear protective gloves, to avoid the risk of serious injury to hands.

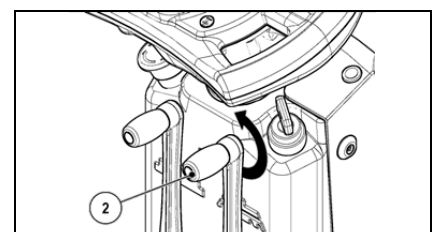
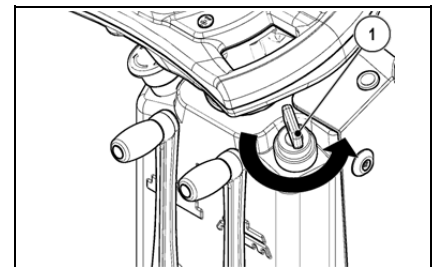



EMERGENCY MAINTENANCE

4. Open the left cover (3) (depending on the direction of travel).
5. Make sure there is about 2 mm between the left flap (4) and the ground, otherwise loosen the nuts (5) and make the adjustment using the proper tool.



ATTENTION: For the correct operation of the machine the distance of the flap from the ground must be even throughout its length.

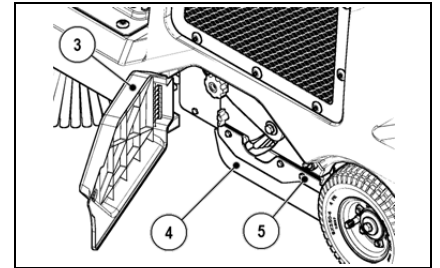

6. Make sure there is about 2 mm between the rear flap (6) and the ground, otherwise loosen the nuts (7) and make the adjustment using the proper tool.



ATTENTION: For the correct operation of the machine the distance of the flap from the ground must be even throughout its length.

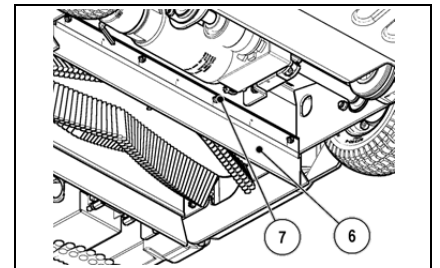

7. Open the right cover (8) (depending on the direction of travel).
8. Make sure there is about 2 mm between the right flap (9) and the ground, otherwise loosen the nuts (10) and make the adjustment using the proper tool.



ATTENTION: For the correct operation of the machine the distance of the flap from the ground must be even throughout its length.

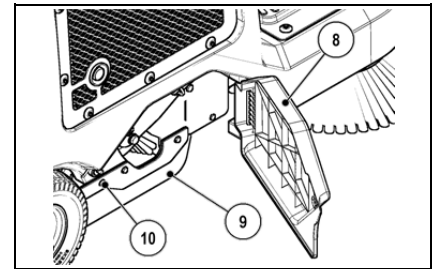

41. CENTRAL BRUSH REPLACEMENT

If the central brush is worn, this will affect its performance. Proceed as follows to replace it:

1. Make sure the electric brake is engaged, otherwise engage it using the lever located at the left rear of the machine (working direction).
2. Check the main switch (1) is in the "0" position, if this is not the case, turn the key by a quarter of a turn to the left, and remove the key from the instrument panel.
3. Check that the central brush is lifted from the ground, otherwise turn the lever (2) counter-clockwise.



ATTENTION: users are advised to always wear protective gloves, to avoid the risk of serious injury to hands.

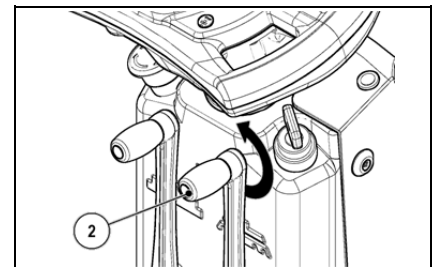
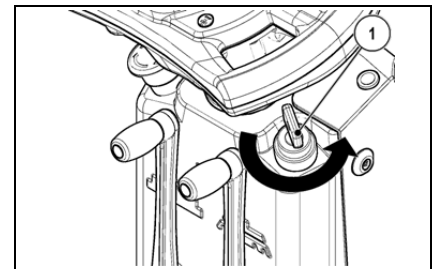

4. Open the left cover (3) (depending on the direction of travel).
5. Remove the knobs (4) securing the left casing of the brush, turning them counter-clockwise.

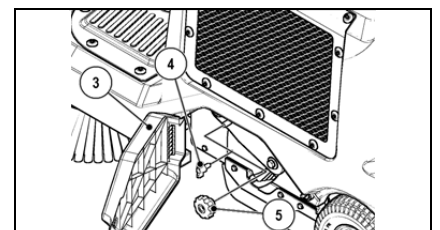



EMERGENCY MAINTENANCE

6. Remove the knob (5) that secures the lifting arm of the brush, by turning it counter-clockwise.
7. Remove the lifting arm (6) and the left side casing (7) of the brush.

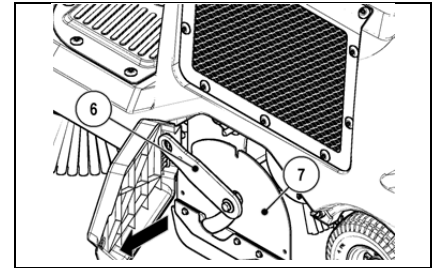

8. Remove the brush from the tunnel and replace it with the new one.
9. Repeat the operations in reverse order to reassemble all the parts.



ATTENTION: The brush must have the cusp facing towards the front of the machine to be fitted in the correct manner.

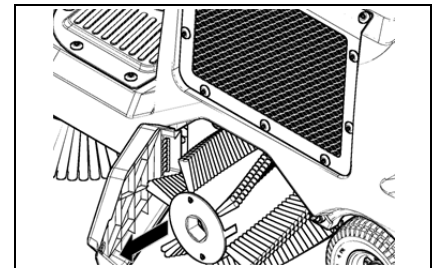

42. REPLACING THE SIDE BRUSH

If the side brush is worn, it can no longer push the side dirt towards the centre of the machine, it is recommended that it be replaced, and to do this proceed as follows:

1. Make sure the electric brake is engaged, otherwise engage it using the lever located at the left rear of the machine (working direction).
2. Check the main switch (1) is in the "0" position, if this is not the case, turn the key by a quarter of a turn to the left, and remove the key from the instrument panel.
3. Check that the side brush is lifted from the ground, otherwise turn the lever (2) clockwise.

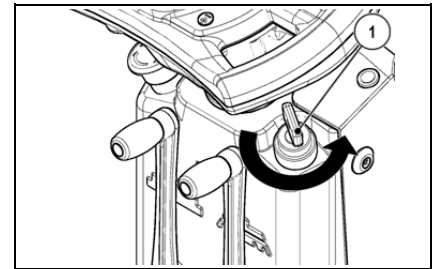

ATTENTION: users are advised to always wear protective gloves, to avoid the risk of serious injury to hands.

4. Remove knob (3) fixing the side brush to the gear motor by rotating clockwise the right brush and counter-clockwise the left brush.
5. Remove the side brush locking washer (4).

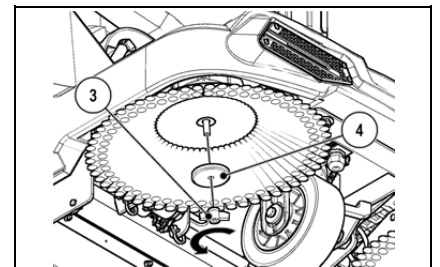
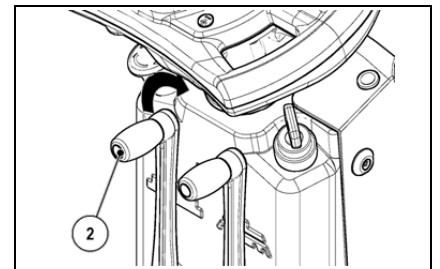

6. Remove the brush and replace it with the new one.
7. Repeat the operations in reverse order to reassemble all the parts.

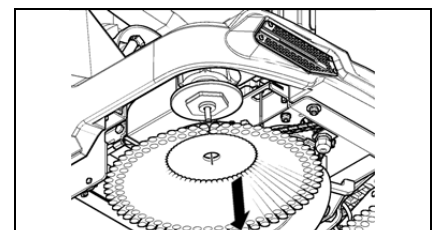



MAINTENANCE OF THE COMBUSTION ENGINE

Good maintenance of the combustion engine is essential for the safe use of the machine, to do so proceed as follows:

1. Make sure the electric brake is engaged, otherwise engage it using the lever located at the left rear of the machine (working direction).
2. Check the main switch (1) is in the "0" position, if this is not the case, turn the key by a quarter of a turn to the left, and remove the key from the instrument panel.
3. Grasp the handle located on the side of the operator seat unit.
4. Lift the operator seat unit until the safety clamp (2) is hooked.

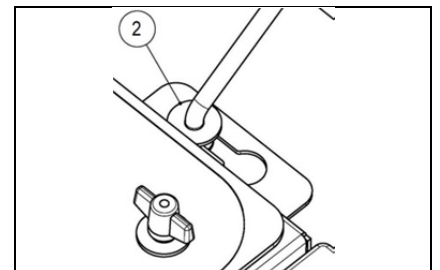
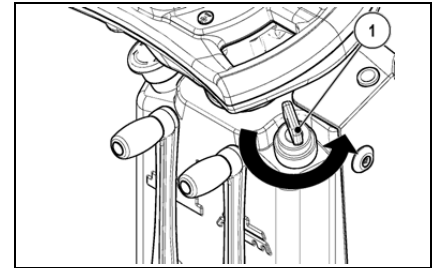

ATTENTION: Users are advised to always wear protective gloves, to avoid the risk of serious injury to their hands.



ATTENTION: With regard to the maintenance of the combustion engine, following the instructions given in the user manual of the combustion engine (supplied with the machine).



ATTENTION: Use the filler cap/dipstick (3) for the control of the engine oil level.

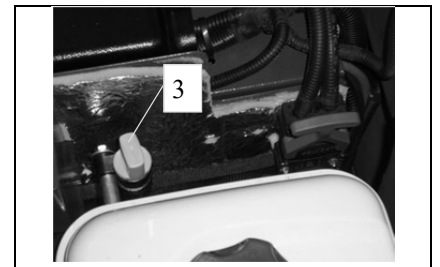

ATTENTION: Use the pipe (4) to change the engine oil.

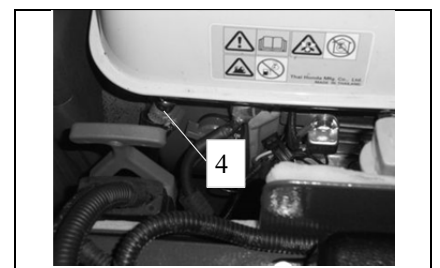



TROUBLESHOOTING

43. THE MACHINE DOES NOT START

1. Make sure that the key switch is turned to "I" or "II", depending on the type of power source you want to use.
2. Make sure the battery connector is connected to the connector of the machine system.
3. Check that batteries are charged.
4. Check there is fuel in the motor tank (Hybrid versions).

44. THE COMBUSTION ENGINE DOES NOT START



ATTENTION: If the combustion engine does not start, check the diagnostics in the motor user manual (the booklet supplied with the machine itself)

45. THE MACHINE DOES NOT CLEAN WELL

1. Check the state of wear and tear of the brushes and, if necessary, replace them. The brushes should be changed when the bristles are about 10 mm long. To replace them, see "CENTRAL BRUSH REPLACEMENT", or "SIDE BRUSH REPLACEMENT". Working with over-worn brushes may cause damage to the floor.
2. Use a different kind of brush to the one fitted as standard. For cleaning floors where the dirt is particularly resistant, we recommend the use of special brushes supplied upon request and according to needs (see "CHOOSING AND USING THE BRUSHES").
3. The side brush is worn, to adjust it see "SIDE BRUSH ADJUSTMENT".
4. The debris hopper is full, empty it completely.

46. THE MACHINE RAISES DUST WHEN OPERATING

1. The flaps that ensure efficient vacuum action are worn: replace them.
2. The front flap is broken and the machine projected heavy dirty bodies forward: replace them.
3. The filter is blocked: clean the filter thoroughly.
4. Check the central brush is correctly assembled
5. The debris hopper position is not correct

47. EXCESSIVE OR ALTERED NOISE OF THE CENTRAL BRUSH

1. Material wrapped around the brush: remove it.

48. EXCESSIVE OR ALTERED NOISE OF THE SIDE BRUSH

1. Material wrapped around the brush: remove it.



DISPOSAL

To dispose of the machine, take it to a demolition centre or an authorised collection centre.

Before scrapping the machine, it is necessary to remove and separate out the following materials, then send them to the appropriate collection centres in accordance with the environmental hygiene regulations currently in force:

- brushes
- felt
- electric and electronic parts*
- batteries
- plastic parts (tanks and handlebars)
- metal parts (levers and frame)
- endothermic engine
- hydraulic oil**

(*) In particular, contact your local distributor when scrapping electric and electronic parts.

(**) In particular, contact your area distributor in order to scrap the hydraulic oil.



CHOOSING AND USING THE BRUSHES

POLYPROPYLENE BRUSH (PPL)

It is used on every type of floors and has good resistance to wear. The polypropylene is non-hygroscopic and therefore retains its characteristics even when working in wet conditions.

THICKNESS OF THE BRISTLES

The thicker bristles are more rigid and should therefore be used on surfaces with solid or heavy dirt (e.g. gravel; drinking cans; etc.).

Softer bristles are recommended for surfaces with light dirt or dust.

Remember that when the bristles are worn, and therefore too short, they become rigid and cannot pick up the dirt efficiently.

The central brush has bristles of 1.1 mm and of 0.7 mm to comply with both characteristics.

TABLE FOR CHOOSING THE BRUSHES

Machine	No. Br.	Code	Type of bristles	Ø Bristles	Ø Br.	Length	Notes
FSR B – HYBRID 1SL	1	437902	PPL + PPL + BRONZE	0.7 + 1.1 + //	260	580	CENTRAL BRUSH
		438621	TAMPICO BASSINE		260	580	CENTRAL BRUSH
	1	437874	PPL	1	400		SIDE BRUSH
FSR B – HYBRID 2SL	1	437902	PPL + PPL + BRONZE	0.7 + 1.1 + //	260	580	CENTRAL BRUSH
		438621	TAMPICO BASSINE		260	580	CENTRAL BRUSH
	2	437874	PPL	1	400		SIDE BRUSH



EC DECLARATION OF CONFORMITY

The undersigned manufacturer:
FIMAP S.p.A.
Via Invalidi del Lavoro, 1
37050 Santa Maria di Zevio (VR)
declares under its sole responsibility that the products

SWEEPING MACHINES mod. FSR B

comply with the provisions of Directives:

- 2006/42/EC: Machinery Directive.
- 2004/108/EC: Electromagnetic compatibility directive.

They also comply with the following standards:

- EN 60335-1: Household and similar electrical appliances - Safety. Part 1: Generic standards.
- EN 60335-2-72: Household and similar electrical appliances. Part 2: Specific standards for automatic machines for floor treatment for commercial and industrial use.
- EN 12100-1: Machine safety - Fundamental concepts, fundamental principles for design - Part 1: Basic terminology and methodology.
- EN 12100-2: Machine safety - Fundamental concepts, fundamental principles for design - Part 2: Technical principles.
- EN 61000-6-2: Electromagnetic compatibility (EMC) - Part 6-2: Generic standards – Immunity for industrial environments.
- EN 61000-6-3: Electromagnetic compatibility (EMC) - Part 6-3: Generic standards — Standard emission for residential, commercial and light-industrial environments.
- EN 62233: Household and similar electrical appliances - Electromagnetic fields - Methods for evaluation and measurement.

The person authorized to compile the technical file:

Mr. Giancarlo Ruffo
Via Maestri del Lavoro, 13
37059 Santa Maria di Zevio (VR) - ITALY

Santa Maria di Zevio (VR), 04/09/2013

Legal representative
Giancarlo Ruffo

FIMAP S.p.A.

The undersigned manufacturer:



FIMAP S.p.A.
Via Invalidi del Lavoro, 1
37050 Santa Maria di Zevio (VR)
declares under its sole responsibility that the products

SWEEPING MACHINES mod. FSR B CB

comply with the provisions of Directives:

- 2006/42/EC: Machinery Directive.
- 2006/95/EC: Low Voltage Directive.
- 2004/108/EC: Electromagnetic compatibility directive.

They also comply with the following standards:

- EN 60335-1: Household and similar electrical appliances - Safety. Part 1: Generic standards.
- EN 60335-2-72: Household and similar electrical appliances. Part 2: Specific standards for automatic machines for floor treatment for commercial and industrial use.
- EN 60335-2-29: Household and similar electrical appliances. Part 2: Special standards for battery chargers.
- EN 12100-1: Machine safety - Fundamental concepts, fundamental principles for design - Part 1: Basic terminology and methodology.
- EN 12100-2: Machine safety - Fundamental concepts, fundamental principles for design - Part 2: Technical principles.
- EN 61000-6-2: Electromagnetic compatibility (EMC) - Part 6-2: Generic standards – Immunity for industrial environments.
- EN 61000-6-3: Electromagnetic compatibility (EMC) - Part 6-3: Generic standards — Standard emission for residential, commercial and light-industrial environments.
- EN 61000-3-2: Electromagnetic compatibility (EMC) - Part 3-2: Limits – Limits for harmonic current emissions (Equipment with input current ≤ 16 A per phase).
- EN 61000-3-3: Electromagnetic compatibility (EMC) - Part 3-3: Limits – Restriction of voltage variations and flicker in low voltage power supply systems for devices with a rated current ≤ 16 A.
- EN 55014-1: Electromagnetic compatibility - Regulations for household appliances, electrical devices and similar equipment. Part 1: Emission - Regulation for product family.
- EN 55014-2: Electromagnetic compatibility - Regulations for household appliances, electrical devices and similar equipment. Part 2: Immunity - Regulation for product family.
- EN 62233: Household and similar electrical appliances - Electromagnetic fields - Methods for evaluation and measurement.

The person authorized to compile the technical file:

Mr. Giancarlo Ruffo
Via Maestri del Lavoro, 13
37059 Santa Maria di Zevio (VR) - ITALY

Santa Maria di Zevio (VR), 04/09/2013

Legal representative
Giancarlo Ruffo

FIMAP S.p.A.

The undersigned manufacturer:
FIMAP S.p.A.



Via Invalidi del Lavoro, 1
37050 Santa Maria di Zevio (VR)
declares under its sole responsibility that the products

SWEEPING MACHINES mod. FSR Hybrid

comply with the provisions of Directives:

- 2006/42/EC: Machinery Directive.
- 2004/108/EC: Electromagnetic compatibility directive.
- 2000/14/EC: Directive by the European Parliament and Council date 8th May, 2000. Noise emission by machines and equipment for outdoor use.

Falling into the category of road sweeper as defined in Annex 46 of Directive 2000/14/EC of the European Parliament and the Council, is subject to noise marking only.

The conformity evaluation was carried out in accordance with attachment III.B.46 of the said directive.

MODEL	LwA, guaranteed [dB(A)]
FSR Hybrid	100

They also comply with the following standards:

- EN 60335-1: Household and similar electrical appliances - Safety. Part 1: Generic standards.
- EN 60335-2-72: Household and similar electrical appliances. Part 2: Specific standards for automatic machines for floor treatment for commercial and industrial use.
- EN 60335-2-29: Household and similar electrical appliances. Part 2: Special standards for battery chargers.
- EN 12100-1: Machine safety - Fundamental concepts, fundamental principles for design - Part 1: Basic terminology and methodology.
- EN 12100-2: Machine safety - Fundamental concepts, fundamental principles for design - Part 2: Technical principles.
- EN 61000-6-2: Electromagnetic compatibility (EMC) - Part 6-2: Generic standards – Immunity for industrial environments.
- EN 61000-6-3: Electromagnetic compatibility (EMC) - Part 6-3: Generic standards — Standard emission for residential, commercial and light-industrial environments.
- EN 62233: Household and similar electrical appliances - Electromagnetic fields - Methods for evaluation and measurement.

The person authorized to compile the technical file:

Mr. Giancarlo Ruffo
Via Maestri del Lavoro, 13
37059 Santa Maria di Zevio (VR) - ITALY

Santa Maria di Zevio (VR), 04/09/2013

Legal representative
Giancarlo Ruffo

FIMAP S.p.A.



FIMAP spa

Via invalidi del lavoro, 1 – cap 37059 – Santa Maria di Zevio (VR) – Italia
Fax. 0039 045 6060417 – Tel. 0039 045 6060411
e-mail: info@fimap.com – web: www.fimap.com